



LISTA DE NOVEDADES

INCOPORACIONES AL:



CATALOGO GENERAL



CATALOGO CHAJA



CATALOGO BOMBAS Y CILINDROS



CATALOGO PASTILLAS DE FRENO



CATALOGO TREN DELANTERO



Av. Mitre 1293 - (1878) Quilmes, Bs. As. - Rep. Argentina - WWW.ITALFREN.COM.AR - info@italfren.com.ar

(011) 7504-4545 / 4618 (Telecentro) - (011) 5057-8417 Whatsapp

Fax s/cargo 0800-222-2047



LISTA DE NOVEDADES



CUBETAS PARA BOMBAS Y CILINDROS



Cód.	Med.	Aplicación	Ilustración	Incorp.
B70261	7/8"	CUBETA P/BOMBA - TIPO ORIGINAL -		JUL-24
B78132	5/8"	CUBETA PRIMARIA BOMBIN TOYOTA		JUL-24



REPARACIONES DE FRENOS A DISCO



Cód.	Med.	Aplicación	Ilustración	Incorp.
C3033	80mm	REP. CALIPER DELANTERO DODGE RAM 2500		JUN-23
C3093	45mm	REP. CALIPER DEL. RENAULT MASTER - MB. SPRINTER - BOSCH		OCT-22
C3201	36mm	REP. CALIPER TRASERA TOYOTA COROLLA		OCT-22
C3202	38mm	REP. CALIPER TRASERO PEUGEOT 307/308 - CITROEN C4		JUN-23
C4612	38mm	REP. CALIPER TRASERA COMPLETA (GOMA+METAL) CITROEN C5 -FORD FOCUS - FOCUS C-MAX - KUGA - RENAULT LAGUNA - MEGANE - VOLVO S40 - V50		OCT-22
C5585	35mm	REP. CALIPER CHEVROLET ASTRA - VECTRA		JUL-24
C10142	48mm	REP. CALIPER TRASERA VOLKSWAGEN AMAROK V6		MAR-24



LISTA DE NOVEDADES

Cód.	Med.	Aplicación	Ilustración	Incorp.
C10144	48mm	REP. CALIPER TRASERA FORD TRANSIT		MAR-24
C10145	54mm	REP. CALIPER DELANTERA PEUGEOT 208 (MOPAR)		OCT.-24



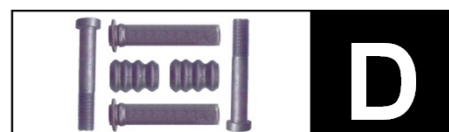

JUEGOS DE PERNOS GUIA P/CALIPERS Y SUS PARTES



Código	Aplicación	Imagen	Sist.	Ubic.	Medida	Incorp
D7216S	KIT PERNOS DESLIZ. C/FUELLES FORD EXPLORER - F-150 97/02 - RANGER - SUPERMEDIDA		BENDIX	-	70,3 x 10,5	ABR-24
D7787	KIT BUJES DE CALIPERS MERCEDES BENZ SPRINTER 411 - 414 19/..		BREMBO	DEL. TRAS.	BUJE 63 x 18 PERNO 12 x 84	MAR-24
D7864	NUEVA APLICACIÓN: KIT PERNOS DE CALIPER FORD FIESTA KINETIC DESIGN				70 x 9,5	OCT-22
D7871	KIT DE PERNOS DESLIZ. C/ FUELLES PEUGEOT 206 - 306		BOSCH	-	68,50x10	AG-22
D7872	KIT DE PERNOS DESLIZANTES C/FUELLES HYUNDAI TUCSON 12/.. - KIA SPORTAGE 12/..		-	-	72x9,85	AG-22
D8081	KIT PERNOS CHEVROLET AVEO		-	-	59x10	AG-22



LISTA DE NOVEDADES

Código	Aplicación	Imagen	Sist.	Ubic.	Medida	Incorp
D8084	KIT BUJES C/RECTIFICADO Y CROMO DURO IVECO 70C16 - 70HD		-	-	90x22	AG-22
D8084/K	KIT BUJES C/RECTIFICADO Y CROMO DURO + TORNILLOS IVECO 70C16 - 70HD		-	-	90x22 120x12	AG-22
D8084/KF	KIT BUJES C/RECTIFICADO Y CROMO DURO + TORNILLOS C/FUELLES IVECO 70C16 - 70HD (KIT COMPLETO)		-	-	90x22 120x12	AG-22
D8086	KIT PERNOS Y FUELLES - COMPLETO- RENAULT MASTER II 12/..		BREMB		80x18	ABR-24
D8092	KIT VOLKSWAGEN AMAROK		-	TRAS	77 alt. 9,9 diam.	MAY-24



REPARAC. DE SERVO NACIONAL - IMPORTADO



Código	Sist.	Imagen	Aplicación	Incorp
E1024D	TRW LUCAS GIRLING		DIAFRAGMA PARA SERVO SIMPLE FORD COURIER - FIESTA - KA - DIAM. EXT. 240mm - AGUJ. INT. 55mm	ABR-24
E1030	ATE		JGO. REP. SERVO RENAULT LOGAN - SANDERO	ABR-23
E1148C	AISIN		VALVULA CONTROL TOYOTA CAMRY - HILUX - SW4 // SUZUKI VITARA - OTROS ASIATICOS	OCT-24



LISTA DE NOVEDADES

Código	Sist.	Imagen	Aplicación	Incorp
E1155S	BOSCH		SELLO P/SERVO E1155	OCT-24
E1177	ATE		JUEGO DE REPARACIONES P/SERVO DT CHEVROLET CRUZE	AG-22
E1177DA	ATE		DIAFRAGMA SUPERIOR CHEVROLET CRUZE (similar a diafragma VW Amarok pero más chico) - Ø EXT.: 224mm - Ø AGUJ.: 35mm - ENTRECENTROS 100mm	-
E1177DB	ATE		DIAFRAGMA INFERIOR CHEVROLET CRUZE (similar a diafragma VW Amarok pero más chico) - Ø EXT.: 241mm - Ø AGUJ.: 58mm - ENTRECENTROS 100mm	-
E1178	AISIN		JUEGO REP. PARA SERVO SIMPLE TOYOTA COROLLA - E120 - FUNCARGO - VITZ	AG-22
E1178D	AISIN		DIAFRAGMA PARA SERVO SIMPLE TOYOTA COROLLA - E120 - FUNCARGO - VITZ - Ø EXT.: 241mm - Ø AGUJ.: 38mm	-
E1179	TRW		JUEGO REP. PARA SERVO SIMPLE CHEVROLET CRUZE - OTROS	AG-22
E1179D	TRW		DIAFRAGMA PARA SERVO SIMPLE CHEVROLET CRUZE - OTROS (similar al E1155D, tetones grandes) - Ø EXT.: 270mm - Ø AGUJ.: 52mm - ENTRECENTROS 105mm	-
E1180	ATE		JUEGO REP. PARA SERVO VW PASSAT - TIGUAN	OCT-23
E1180D	ATE		DIAFRAGMA PARA SERVO VW PASSAT - TIGUAN - Ø EXT.: 290mm	OCT-23
E1181	KDAC		JUEGO REP. SERVO CHEVROLET SPIN (CON TETONES) - Ø EXT.: 265mm	ABR-24





LISTA DE NOVEDADES

Código	Sist.	Imagen	Aplicación	Incorp
E1181D	KDAC		DIAFRAGMA PARA SERVO CHEVROLET SPIN (CON TETONES) - Ø EXT.: 265mm	OCT-23
E1182	NISSIN		JGO. REP. SERVO SIMPLE C/TETONES HONDA NEW CIVIC	OCT-24
E1182D	NISSIN		DIAF. SERVO SIMPLE C/ TETONES HONDA NEW CIVIC (USO EN REPARACION 1182)	OCT-24
E1183	NISSIN		JGO. REP. SERVO SIMPLE HONDA CITY - FIT	OCT-24
E1183D	NISSIN		DIAF. SERVO SIMPLE HONDA CITY - FIT (USO EN REPARACION 1183)	OCT-24
E1183S	NISSIN		SELLO P/SERVO E1182 Y E1183	OCT-24
E1616	ATE BOSCH		VALVULA CONTROL CITROEN C4 - C3 - AIRCROSS // PEUGEOT 308 - 408 - 508 - 2008 - 3008 // TOYOTA ETIOS - COROLLA // FORD FIESTA KINETIC - OTROS	OCT-24
E5476	ATE		DIAFRAGMA RENAULT LOGAN - SANDERO - Ø EXT.: 236mm	ABR-23
E9954	ATE BOSCH		REP. VALV. CONTROL CITROEN C4 - C3 - AIRCROSS // PEUGEOT 308 - 408 - 508 - 2008 - 3008 // TOYOTA ETIOS - COROLLA // FORD FIESTA KINETIC - OTROS	OCT-24
E9956	AISIN		JGO. REP. VALV. CONTROL TOYOTA CAMRY - HILUX - SW4 // SUZUKI VITARA	OCT-24
E41145	ATE BOSCH		PISTON P/REP. VALV. CONTROL CITROEN C4 - C3 - AIRCROSS // PEUGEOT 308 - 408 - 508 - 2008 - 3008 // TOYOTA ETIOS - COROLLA / FORD FIESTA KINETIC - OTROS	OCT-24





LISTA DE NOVEDADES

Código	Sist.	Imagen	Aplicación	Incorp
E41144	AISIN		PISTON P/JGO. REP. VALV. CONTROL TOYOTA CAMRY - HILUX - SW4 // SUZUKI VITARA	OCT-24



DESPIECE Y REPARAC. SERVO TENSA

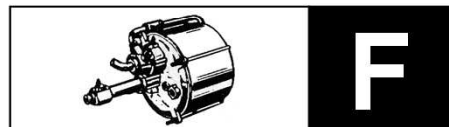

F

Cód.	Imagen	Descripción	Incorp.
FT9629/1		VALVULA RETENCION SERVO TENSA - ORIGINAL P/CURVO	MAY-24



PISTONES PARA CALIPERS



G

Cód.	Ø	Alt.	Descripción	Sistema	Imagen	Incorp
G01036	36	49	TOYOTA COROLLA 06/.. (TRASERO)	-		OCT-22
G01037	36	49	KIT PIST. MORDAZA TOYOTA COROLLA 06/.. - TRASERO/DERECHO	-		AGO-24
G01038	36	49	KIT PIST. MORDAZA TOYOTA COROLLA 06/.. - TRASERO/IZQUIERDO	-		AGO-24
G01039	54	51	FIAT GRAND SIENA FORD ECOSPORT	-		AG-22
G01041	57	56	A. ROMEO GIULIETTA - AUDI A4 - A5 - Q3 - BMW SERIE 3 - XI - Z4 - CITROEN C4 - FIAT DOBLO - 500 - FORD C-MAX - FOCUS - KUGA - MONDEO - TRANSIT - HONDA ACCORD - CIVIC - IVECO DAILY	-		AG-22





LISTA DE NOVEDADES

Cód.	Ø	Alt.	Descripción	Sistema	Imagen	Incorp
G01042	34	46	HYUNDAI TUCSON (TRASERO) KIA SPORTAGE (TRASERO)	-		AG-22
G01043	48	54	RENAULT MASTER II 12/.. (TRASERO)	-		OCT-22
G01044	30	44	HONDA CITY - FIT 10/.. (TRASERO)			AG-23
G01045	54	48	HONDA CITY - FIT 10/.. (TRASERO)	-		OCT-22
G01046	54	49	CHEVROLET SIPIN	-		AGO-24
G01047	57	53,85	CHRYSLER PT CRUISER	-		AGO-24
G01049	60	55	FIAT TORO - JEEP RENEGADE - PEUGEOT 208 (DELANTERO)	-		SEPT-24
G01053	52	51	CHEVROLET COBALT - ONIX - PRISMA	-		OCT-24



FLEXIBLES PARA FRENOS

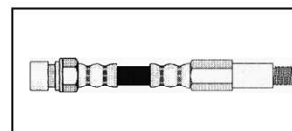











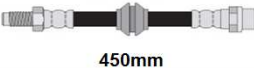





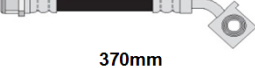
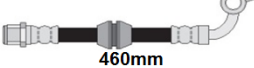

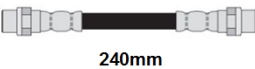
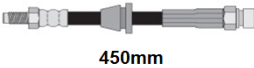
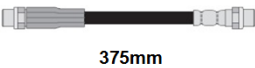
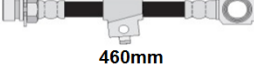
H

Código	Imagen	Descripción	Incorp.	Código	Imagen	Descripción	Incorp.
ALFA ROMEO							
				H2235		33 88/92 145 - 156 94/.. 155 TS 6V 92/.. VER TRAS	JUL-24
					185mm		



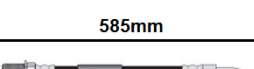
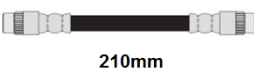

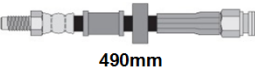
LISTA DE NOVEDADES

Código	Imagen	Descripción	Incorp.	Código	Imagen	Descripción	Incorp.
BMW							
H7315	 450mm	SERIE 3 316, 318, 320, 323, 325, 318 TDS, 325 TDS 91/.. DEL	JUL-24				
CHEVROLET							
H4007	 344mm	VERANEIO C10, C15 74/.. DEL	JUL-24	H4067	 210mm	LUMINA APV VAN 3.1, 3.4, 3.8 90/96 TRAS	JUL-24
H4087	 345mm	ASTRA 91/97 KADETT E 85/.. VER DEL	JUL-24	H4095	 244mm	KADETT (F/D 4RDAS), MONZA 88/.. TRAS	JUL-24
H4124	 370mm	CRUZE 17/.. DEL/DER	MAY-24	H4125	 370mm	CRUZE 17/.. DEL/IZQ	MAY-24
H4136	 460mm	ONIX PLUS LT 20/.. DEL/DER	MAY-24	H4137	 460mm	ONIX PLUS LT 20/.. DEL/IZQ.	MAY-24
H4138	 420mm	ONIX LT, LTZ ONIX PLUS LT, L 20/.. TRAS	MAY-24	H4145	 240mm	AGILE 10/17 CELTA 10/15 VER TRAS	MAY-24
H4114/1	 450mm	ONIX 13/.. - PRISMA - SPIN 12/.. VER DEL.	OCT-22	H4121	 375mm	TRACKER (FRENO A TAMBOR) 13/.. TRAS	OCT-22
H82034	 460mm	LUMINA APV VAN 3.1, 3.4 90/91 DEL/DER	JUL-24	H4181	 250mm	ZAFIRA 99/.. TRAS	JUL-24
H82065	 430mm	LUMINA APV VAN 3.1, 3.4 90/91 DEL/IZQ	JUL-24	H82337	 320mm	LUMINA 91/94 TRAS	JUL-24
H86002	 585mm	BLAZER 2WD (USA) JIMMY, YUKON 2WD 73/78 DEL/DER	JUL-24	H86304	 380mm	BLAZER 2WD, 4WD (USA) 74/91 JIMMY, YUKON 2WD, 4WD 74/91 IMPALA STATION WAGON 74/76 VER TRAS	JUL-24
H86003	 585mm	BLAZER 2WD (USA) JIMMY, YUKON 2WD 73/78 DEL/IZQ	JUL-24				
CITROEN							
H8104	 210mm	C3 04/.. TRAS	JUL-24	H8127	 400mm	XANTIA 93/.. DEL	JUL-24
H8129	 470mm	XSARA 1.4, 1.6 F/T, C/ABS F/D 97/.. - ZX 1.6, 2.0, BREAK 91/.. VER DEL	JUL-24	H8130	 490mm	JUMPER (2 por rda.) 94/.. DEL	JUL-24
				H46039	 265mm	XSARA 1.4, 1.6 C/ABS F/D (D/DER) 97/.. - ZX BREAK 91/.. VER TRAS	JUL-24



LISTA DE NOVEDADES

Código	Imagen	Descripción	Incorp.	Código	Imagen	Descripción	Incorp.
DAIHATSU							
H17072		A10 1.2 76/78 - A20 1.4 76/79 F/T y F/D	JUL-24	H17078		A35, 45, 60, CHARMANT 1.3 y 1.6 (TRAS) 82/86 - A201.4, CHARMANT 1.4 76/80 (EMBR.)	JUL-24
		VER				DEL	
H43867 EX H1391		FEROZA, ROCKY	JUL-24				
	281mm				285mm		
	570mm	89/92	DEL				
DODGE							
H8386		RAM 1500, 2500 (ABS atrás)	JUL-24	H87058		RAM 1500, 2500 (ABS atrás)	JUL-24
	500mm	95/99	D/IZQ		476mm	94/99	D/DER
H33972		D100 - BOMBA MAESTRA	JUL-24	H33972/1		D100 - BBA. MAESTRA C/MACHO FIJO 7/16"x20	JUL-24
	185mm				190mm		
H41574		D500, D600 59/60 - D200, D250, D700, '60 - M300 69/76 - P200 '61 - P300, P350 69/78 - W100, W150, '59 - W300, W350 61/71	JUL-24	H87310		A100, D150 78/89 - D100, D150, D200, D250, D300, D350 82/89	JUL-24
	628mm	VER	DEL		660mm	VER	TRAS
H87324		D100, D150 78/89 - D100, D150, D200, D250, D300, D350 82/89	JUL-24				
	667mm	VER	TRAS				
FIAT							
H2039		MOBI	MAY-24	H2114		PUNTO	OCT-22
	240mm	16/..	TRAS		455mm	09/..	DEL.
H2130		ARGO 17/.. - CRONOS 18/.. - MOBI 17/..	MAY-24	H2137		ARGO - CRONOS - FASTBACK - PULSE	MAY-24
	530mm	VER	DEL.		210mm	TRAS	
H2141		NVO. STRADA	MAY-24	H2230		TORO 07/19 DOBLO 07/..	OCT-22
	330mm	21/..	DEL.		435mm	VER	DEL.
H2231		TORO 07/19 DOBLO 07/..	OCT-22	H2235		TIPO C/ABS 88/..; TEMPRA 1.4, 1.6 C/ABS Y 1.8, 1.9D/TD C/ABS 89/.. - BARCHETA, BRAVO-BRAVA 2.0 95/.. - MAREA 2.0 20V Y 2.4 TD 97/.. - PUNTO GT 97/..	AGO-24
	310mm	VER	TRAS.		185mm	VER	TRAS.
H2236		BARCHETA - BRAVO - BRAVA 2.0D - UNO	AGO-24	H9138		500X	OCT-22
	175mm	95/..	TRAS.		440mm	14/..	DEL.
H9140		500X	OCT-22	H248484E		DUNA ELBA FIORINO PREMIO UNO - H-H 10x1	MAY-24
	385mm	14/..	TRAS.			TRAS.	
FORD							
H3092		FOCUS	AGO-24	H3095		FOCUS S/ABS	AGO-24
	380mm	00/..	DEL		220mm	99/..	TRAS



LISTA DE NOVEDADES

Código	Imagen	Descripción	Incorp.	Código	Imagen	Descripción	Incorp.
FORD - cont.							
H3097		FOCUS C/ABS	AGO-24	H3113		F4000 99/.. - F250 99/04 - F350 SUPER DUTY 4X4, C/BLOQUEO DE EJES MANUAL ABS TRASERO, PICK-UP Ó CHASIS ESTRECHO 99/04	AGO-24
		190mm				99/..	
H3115		F250 - F350 SUPER DUTY 4X4, C/BLOQUEO DE EJES MANUAL, ABS EN LAS 4 RUEDAS, PICK-UP Ó CHASIS ESTRECHO	AGO-24	H3117		F4000 99/.. - F250 99/04 - F350 SUPER DUTY 4X4, C/BLOQUEO DE EJES MANUAL ABS TRASERO, PICK-UP Ó CHASIS ESTRECHO 99/04	AGO-24
		635mm				99/04	
H3123		F4000 (F/D)	OCT-22	H3124		F4000 (F/D)	OCT-22
		270mm					
H3140		RANGER (USA) 4WD - BRONCO II	AGO-24	H3141		RANGER (USA) 4WD - BRONCO II	AGO-24
		612mm				'86	
H3162		EXPLORER 1992 - RANGER (USA) 4WD 92/94	AGO-24	H3163		EXPLORER 1992 - RANGER (USA) 4WD 92/94	AGO-24
		490mm				VER	
H3192		MONDEO III	OCT-22	H3184		RANGER (DOBLE CONEXIÓN)	OCT-22
		480mm				00/07	
H3198		TRANSIT	MAY-24	H3220		F600 SERIE 6000 F700 SERIE 7000 F800 - F850 SERIE 8000	MAY-24
		380mm				11/..	
H13038		F600 - F700 - F6000 - F7000	AGO-24	H85069		F150 90/91 - BRONCO 90/92	AGO-24
		300mm					
H85070		F150 90/91 - BRONCO 90/92	AGO-24	H85316		F100 80/83 - F150, F200, F250, F300, F350 80/88	AGO-24
		530mm				VER	
H85325		F100 80/83 - F300, F350 80/84 - F150, F200, F250 80/91 - BRONCO 80/92	AGO-24	H85329		F150 /92/96 - F200, F250, F300, F350 92/98 - BRONCO 93/96	AGO-24
		454mm				VER	
H85332		F150, 4WD, F/T	AGO-24	H85333		F150 92/95 - F200, F250 92/98 - F300, F350 92/98	AGO-24
		546mm				89/97	
H85341		F150 2WD 96/04 - F200 - F250 2WD 97/00 - RANGER (USA) 03/05 - EXPEDITION 2WD 97/99	AGO-24	H85342		F150 4WD 96/04 - F200 - F250 4WD 97/00 - EXPEDITION 4WD 97/99	AGO-24
		556mm				VER	
HONDA							
H4501		CIVIC 1.1	AGO-24	H4502		ACCORD	AGO-24
		295mm				73/79	
H4503		ACCORD	AGO-24	H4504		ACCORD	AGO-24
		260mm				74/79	
H4506		ACCORD 1.6 SEDAN	AGO-24	H4524		PASSPORT	AGO-24
		510mm				81/83	

















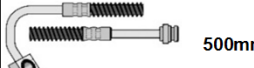
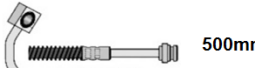



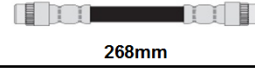

LISTA DE NOVEDADES

Código	Imagen	Descripción	Incorp.	Código	Imagen	Descripción	Incorp.
HONDA - cont.							
H4534		ACCORD 90/97 - ODYSSEY 95/98	AGO-24	H4535		ACCORD 90/97 - ODYSSEY 95/98	AGO-24
		VER DEL/DER				VER DEL/IZQ	
H138624		ACCORD	AGO-24	H138625		ACCORD	AGO-24
		98/00 DEL/DER				98/00 DEL/IZQ	
HYUNDAI							
H4814		H1	MAY-24	H4815		H1	MAY-24
		07/15 DEL/DER				07/15 DEL/IZQ	
H4623		MANGUERA DEPRESOR H 100 94/16 - GALLOPER 2.5 DIESEL 91/03 - K2500	MAY-24	H4569		ELANTRA 01/06 TIBURON 03/08	MAY-24
						TRAS	
H4579		ELANTRA 97/06 F/T ACCENT 95/99 F/T	MAY-24	H4811		HB20	MAY-24
		VER TRAS				11/17 TRAS	
H4819		CRETA	MAY-24				
		15/20 TRAS					
ISUZU							
H4702		FARGO 1.6 VAN, 1.8 VAN/WAGON, DIESEL 82/85; FARGO 1.8, 2.0 DIESEL VAN/WAGON 86/95	AGO-24	H4705		FARGO 1.6 VAN, 1.8 VAN/WAGON, DIESEL 83/85; FARGO 1.8, 2.0 VAN/WAGON DIESEL '86	AGO-24
		VER DEL				VER TRAS	
H4720		ELF 250 DIESEL NPR57 '85 - ELF 350 DIESEL NPR59 85/..	AGO-24	H4724		ELF DIESEL TRUCK NPR57 NPR58 NPR59 87/.. - ELF DIESEL TRUCK NHR54 88/..	AGO-24
		VER DEL				VER TRAS	
H4743		PICK-UP 2.2, 2.3 2WD - FASTER 1.6, 2.3, 2.6 DIESEL TFR/TFS 2WD	AGO-24	H4906		LUV PICK-UP	AGO-24
		88/95 TRAS				81/83 DEL	
H4910		LUV PICK-UP 2WD	AGO-24				
		84/88 DEL					
IVECO							
H2119		DAILY	MAY-24	H2120		DAILY II	MAY-24
		08/.. DEL				90/99 TRAS	
JEEP							
H9120		GRAND CHEROKEE ABS F/D	AGO-24	H9122		GRAND CHEROKEE ABS F/D	AGO-24
		93/98 TRAS/DER				93/98 TRAS/IZQ	
H9128		GRAND CHEROKEE	MAY-24				
		T/D 99/04					
H9138		RENEGADE	OCT-22	H9140		RENEGADE	OCT-22
		16/.. DEL.				16/.. TRAS.	





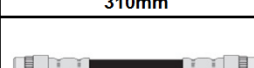







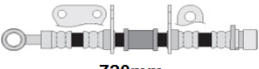
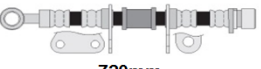

LISTA DE NOVEDADES

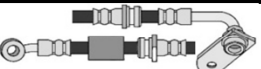
Código	Imagen	Descripción	Incorp.	Código	Imagen	Descripción	Incorp.
KIA							
H8310	 525mm	BESTA GS 2.7L 00/06 DEL	MAY-24	H4622	 320mm	BESTA 2.2L 92/03 - K2500 2.5L 01/04 - K2700 2.7L 93/05 VER DEL	MAY-24
H4816	 410mm	SORENTO II 09/15 DEL/DER	MAY-24	H4817	 410mm	SORENTO II 09/15 DEL/IZQ	MAY-24
H4624	 500mm	SPORTAGE 95/02 DEL/DER	MAY-24	H4626	 500mm	SPORTAGE 95/02 DEL/IZQ	MAY-24
MERCEDES BENZ							
H5054	 550mm	SPRINTER MACHO LARGO 38mm 08/.. DEL/TRAS	MAY-24	H5056	 260mm	SPRINTER 95/06 TRAS	MAY-24
NISSAN							
H5846	 440mm	FRONTIER 18/.. DEL.	OCT-22				
PEUGEOT							
H8114	 225mm	206 98/.. TRAS/DER	AGO-24	H8115	 268mm	206 98/.. TRAS/IZQ	AGO-24
H8162	 210mm	307 02/.. - 308 07/.. - 3008 09/.. VER TRAS	AGO-24	H36237	 420mm	504 - 505 (Anula compensadora)	AGO-24
H85120	 190mm	505 (Reforma - elimina compensadora)	AGO-24				
RASTROJERO							
H89999E	 550 mm	ULTIMA SERIE INDENOR - PUNTERA HEMBRA MAS CHICA D/T	MAY-24				
RENAULT							
H5850	 430mm	ALASKAN 17/.. DEL/DER	MAY-24	H5851	 430mm	ALASKAN 17/.. DEL/IZQ.	MAY-24
H5852	 420mm	ALASKAN 17/.. TRAS	MAY-24	H8206	 320mm	R9 TX - GTX // R11 TX - GTX TRAS	AGO-24
H8213	 310mm	R19 TODOS 96/.. DEL	AGO-24	H8221	 290mm	R21 86/.. - CLIO 90/.. VER TRAS	AGO-24
H8224	 255mm	CLIO 16v +ABS 90/.. TRAS	AGO-24	H8225	 355mm	CLIO II 00/.. DEL	AGO-24

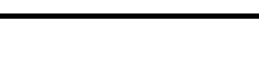

LISTA DE NOVEDADES

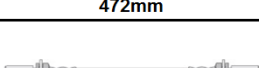
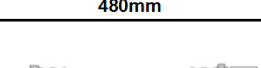
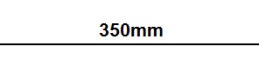
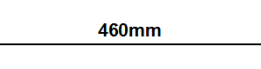
Código	Imagen	Descripción	Incorp.	Código	Imagen	Descripción	Incorp.
RENAULT - cont.							
H8273	 305mm	LOGAN II TRAS.	OCT-22	H57333	 390mm	R18 GTS (Rca. Metrica 10x1) DEL	AGO-24
H252984	 293mm	R18 TRAS	AGO-24				
ROVER - LAND ROVER							
H6098	 720mm	ROVER 618 I/SI - 620 SdI - 620 Si - 620 Ti VITESSE - 623 Si 93/99 DEL/DER	MAY-24	H6099	 720mm	ROVER 618 I/SI - 620 SdI - 620 Si - 620 Ti VITESSE - 623 Si 93/99 DEL/IZQ	MAY-24
H6080	 440mm	LAND ROVER SANTANA D/T					
SUZUKI							
H7852	 775mm	VITARA - GRAND VITARA 98/15 DEL/DER	MAY-24	H7854	 775mm	VITARA - GRAND VITARA 98/15 DEL/IZQ.	MAY-24
H7826	 300mm	SAMURAI 1.3 - 1.9 85/04 DEL.	OCT-22				
TOYOTA							
H117043	 472mm	HILUX 2.0 4WD (RN36, 46 79/83)(YN60, 65 84/85) - HILUX 2.2 4WD (YN67 86/..) - HILUX DIESEL 4WD (LN36, 46 81/83) (LN60, 65 84/..) VER DEL	AGO-24	H117044	 480mm	HILUX 2.0 4WD (RN36, 46 79/83) (YN60, 65 84/85) - HILUX DIESEL 4WD (LN36, 46 81/83) - HILUX 2.2 4WD (YN67 84/85) - HILUX DIESEL 4WD (LN60, 65 84/85) VER TRAS	AGO-24
H117047	 350mm	HILUX 1.6 (YN50, 55), 2.0 (YN52, 57) - HILUX DIESEL (LN50, 55), DIESEL (LN51, 56) 84/.. DEL	AGO-24	H117048	 460mm	HILUX 1.6 RN20, 25 72/78 TRAS	AGO-24
H117049	 430mm	HILUX 1.6 (YN50, 55), 2.0 (YN52, 57) - HILUX DIESEL (LN50, 55), DIESEL (LN51, 56) 84/85 // HILUX 2.0 4WD (YN60, 65), 2.2 4WD (YN67), DIESEL 4WD (LN60, 65) 85/.. // LAND CRUISER(FJ40, 43, 45; BJ40, 42, 43, 45; HJ45, 47) 81/84 - LAND CRUISER (FJ75), DIESEL (BJ75 - H75) 86/.. VER TRAS	AGO-24	H117049	 430mm	LAND CRUISER WAGON (BJ60 81/85), DIESEL (BJ42, 45 81/84) - LAND CRUISER (BJ40, 43 81/84) VER D/CENTRAL	AGO-24
H117072	 285mm	COROLLA 1.2 SEDAN (KE20 F/T, F/D 70/74; KE30 F/T, F/D 74/79); 1.2 LIFTBACK (KE50 76/79), 1.6 LIFTBACK (TE51 76/79) VER DEL	AGO-24	H117078	 285mm	CELICA 1.6 HARDTOP, LIFTBACK (TA23, 27 71/75) (TA23, 28 76/77), 1.6 COUPE, LIFTBACK (TA40B 1978), 2.0 COUPE, LIFTBACK (RA40B 1978) TRASERO // CROWN 2.6 SEDAN (MS85 ROYAL SALOON 75/79) TRASERO Y EMBRAGUE // COROLLA 1.3 SEDAN, LIFTBACK (KE70E 80/83) 1.6 SEDAN, LIFTBACK (TE71E 80/83), 1.6 COUPE (AE86E 83/87 EXCEPTO GT) TRASERO // LITEACE 1.3 (KM20 F/D 80/85); DIESEL (CM20 F/D 83/85); 1.5 (KM36, 37; 86/..), 1.8 (YM 30, 31 86/..); DIESEL (CM35 86/..) DELANTERO // VAN MODEL F 2.0 (YR20, 21) DIESEL (CR21) 83/.. DELANTERO VER VER	AGO-24



LISTA DE NOVEDADES

Código	Imagen	Descripción	Incorp.	Código	Imagen	Descripción	Incorp.
TOYOTA - cont.							
H17087		STOUT 2.0 RK110 (Doble Cab & 1,5 Ton) 84/86 - STOUT 2.2 YK110 (Doble	MAY-24	H17118		HIACE III	MAY-24
	420mm	TRAS			400mm	89/95 DEL/DER	
H17119		HIACE III	MAY-24				
	400mm	89/95 DEL/IZQ.					
VOLKSWAGEN							
H7094		AMAROK V6 - AMAROK 3.0 TDI, 3.0 TDI 4 MOTION (OJAL 10mm)	MAY-24	H7079/1		BORA (OJAL 10mm)	MAY-24
	700mm	16/22 DEL.			260mm	TRAS.	
H7080		T-CROSS	OCT-22	H7088		T-CROSS	OCT-22
	650mm	17/.. DEL.			200mm	17/.. TRAS.	
H7020		VARIANT II	MAY-24	H7084		TOUAREG	MAY-24
	415mm	77/.. DEL.			430mm	03/18 TRAS.	



CABLES DE FRENO, EMBRAGUE Y SELECTORA

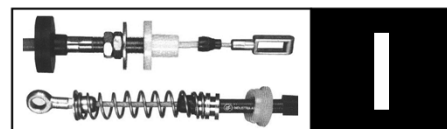

Código	Aplicación	Largo	Nº OEM	Incorp
i268	CAMBIO DE VELOCIDADES AUTOMATICO FORD TAUNUS	1300	78BR7A482A	AG-22
i661	EMBRAGUE FIAT 132 ARGENTA todos - Diesel Bosch 81/..	1130	4380878	ABR-24
i790	EMBRAGUE GM/CHEVROLET/OPEL SUPREMA 2.0 - 2.2 MPFI 4 CIL. 92/98 - SENATOR 88/93	1226	90335385 - 669159	AG-22
i902	EMBRAGUE MANGO HEX. C/2 TUERCAS P-504			ENE-23
i3015	EMBRAGUE FIAT MAREA MOTOR 1.9 TD 95/02	1510	46448106 - 46797595	ENE-24
i3565	EMBRAGUE VW 1600 / SAFARI REFORZADO / KARMAN GHIA Ghia 72/..	2290	111721335C	JUN-22
i3632	FRENO TRAS/D-I VW 1300 - 1500 - 1600 81/86	1770	1136097211 - 113609721L	JUN-22
i3676	EMBRAGUE VW BRAZILIA - REFORZADO	2345	adaptación 311721335A - 3117213351	JUN-22
i3980	EMBRAGUE CON 2 CONTRAPESOS RENAULT 21 - NEVADA - RX - TXE - MEDALLON - ETOILE 87/..	1230	7700763190	AG-22
i4016	CAMBIO DE VELOCIDADES M. BENZ OMNIBUS 1725	10250	A3822600351	AG-22
i4019	CAMBIO DE VELOCIDADES M. BENZ OMNIBUS O500 RS	11000	A6292682891	AG-22
i4055	EMBRAGUE DAEWOO MATIZ 1.0 4V 05/..	835	96590793 - 25187023	AG-22
i4056	EMBRAGUE NISSAN TSURU III 1.6L 03/16	800	30770F4203	AG-22
i4488	EMBRAGUE GM/CHEVROLET/OPEL PICK-UP A10 - A20 - C10 - C20 85/88	730	94647409	AG-22



LISTA DE NOVEDADES

Código	Aplicación	Largo	Nº OEM	Incorp
i4489	EMBRAGUE GM/CHEVROLET/OPEL CAMIÓN D40 85/88	725	94647410	AG-22
i4491	FRENO TRASERO GM/CHEVROLET/OPEL A10 - A20 - C10 - C20 - D10 - D20 85/88	1240	94637224	AG-22
i4495	FRENO DELANTERO FORD F4000 MOTOR MWM ASPIRADO 92/98	2185	T72609701	AG-22
i4539	EMBRAGUE GM/CHEVROLET/OPEL CHEVETTE 74/76	1190	9302835	AG-22
i4540	FRENO DELANTERO GM/CHEVROLET/OPEL A40 - C40 - D40 85/92	1490	94629727	AG-22
i4544	EMBRAGUE GM/CHEVROLET/OPEL PICK-UP A10 - C10 - D10 MOTOR 4 CILINDROS 79/84 - A14C y C14C 85/89	800	94602860	AG-22
i4578	FRENO TRASERO DERECHO/IZQUIERDO A CAMPANA VW POLO HATCH-SEDAN (BRASIL) 02/15	1660	6Q0609721K - 6Q0609721F	AG-22
i4635	CAMBIO DE VELOC. INSERCIÓN FIAT NUEVO PALIO (326) 1.4 MPI FIRE 8V (CAJA C514) ATTRACTIVE 17/..	1100	55261463	AG-22
i4636	CAMBIO DE VELOC. SELECCIÓN FIAT NUEVO PALIO (326) 1.4 MPI FIRE 8V (CAJA C514) ATTRACTIVE 17/..	1185	55261464	AG-22
i4654	CAMBIO DE VELOCIDADES CITROEN NUEVA JUMPER 05/17 - FIAT NUEVA DUCATO 05/18 - PEUGEOT NUEVA BOXER 05/17 - 2 CABLES UNIDOS CON GOMA	1038	71729169 - 2444V9 - 2444EC	AG-22
i4660	FRENO DELANTERO A CAMPANA CHEVROLET ONIX - PRISMA 13/..	190	52026809	AG-22
i4661	FRENO DEL. A CAMPANA CHEVROLET SPIN 12/..	230	52046580 - 52034393	AG-22
i4663	CAMBIO DE VELOCIDADES INSERCIÓN FIAT UNO II 1.4 MPI FIRE 10/.. -RÓTULA GRANDE- (EXT. PLÁSTICOS)	1095	55222272 - 68198829AA	AG-22
i4664	CAMBIO DE VELOCIDADES SELECCIÓN FIAT UNO II 1.4 MPI FIRE 10/.. -RÓTULA CHICA- (EXT. PLÁSTICOS)	1000	55222273 - 68198830AA	AG-22
i4670	CAMBIO DE VELOCIDADES TOYOTA YARIS 1.5 VVTI 16V 6 VELOC. 18/.. -2 CABLES UNIDOS POR GOMA-	1080	338200D760	AG-22
i4671	CAMBIO DE VELOC. CHEVROLET ONIX - PRISMA CAJA DE 5 VELOC. 20/.. -2 CABLES UNIDOS POR GOMA-	1085	24590069 - 24590218	AG-22
i4672	CAMBIO DE VELOCIDADES FORD FIESTA - COURIER 1.6L 16V 5 VELOC. 15/.. -2 CABLES CON GOMA UNIÓN-	1700	D2BZ7E395C	AG-22
i4689	CAMBIO DE VELOCIDADES VW NIVUS 1.0 T AT6 20/..	1400	2Q0713266M	AG-22
i4695	CAMBIO VELOC. FIAT DUCATO - TALENTO 2.3 16V TURBO DIESEL MULTIJET -2 CABLES UNIDOS CON GOMA- 19/..	1050	55284171 - K68403724AA	AG-22
i4712	BIELETA PEDAL DE EMBRAGUE PEUGEOT 206 - 207 - HOGGAR	-	212830	OCT-22
i4713	BIELETA PEDAL DE EMBRAGUE CITROEN BERLINGO - PEUGEOT PARTNER	-	212831	OCT-22
i4716	FRENO TRASERO EXTENSION A CAMPANA CHEVR. ONIX y PRISMA 13/.. - COBALT y SONIC 12/..	230	95492584 - 95231322	OCT-22
i4717	FRENO TRASERO EXTENSION A CAMPANA CHEVR. SPIN 12/.. - TRACKER y TRAX 13/..	235	95492583	OCT-22
i4719	FRENO TRASERO A DISCO FORD FOCUS III 13/.. - 2 CABLES CON CHAPA UNION	1970	AV612A603BL	OCT-22
i4721	CAMBIO DE VELOCIDADES (CAMBIO AT6) CAJA AUTOMATICA - CITROEN C4 CACTUS 1.2 T PURETECH - 1.6 16V 17/... - C-ELYSEE 1.6 16V 17/20 - DS3 1.2 T PURETECH 17/... - PEUGEOT 301 1.6 16V 17/18 - PEUGEOT 208 1.6 16V EC5 12/... - PEUGEOT2008 1.6 16V EC5 16/..	1320	9814628080	AG-22



LISTA DE NOVEDADES

Código	Aplicación	Largo	Nº OEM	Incorp
i4729	CAMBIO VELOC. AUTOMÁT. FORD RANGER 12/..	1255	AB397E395AF	ENE-24
i4730	FRENO TRAS. A CAMPANA (SIN ABS) -2 CABLES CON CHAPA UNIÓN- FORD FOCUS II 08/13	2980	1707756 - 3M512A603EC	MAR-23
i4731	FRENO DE MANO TRASERO A DISCO FORD FOCUS II	3730	1707757 - 3M512A603FC	ENE-24
i4745	FRENO TRASERO DERECHO (SIN CHAPAS SOPORTE) NISSAN FRONTIER MWM 2.8 DTI 03/08	2270	365306S302	AG-22
i4746	FRENO TRASERO IZQUIERDO NISSAN FRONTIER MWM 2.8 DTI 03/08	1095	365316S302	AG-22
i4749	FRENO DELANTERO NISSAN FRONTIER MWM 2.8 DTI 03/08	2215	364028Z311	ENE-24
i4750	FRENO TRASERO DERECHO NISSAN FRONTIER 2.3 DCI 16/18	2175	365304KH0B	ENE-24
i4751	FRENO TRASERO IZQUIERDO NISSAN FRONTIER 2.3 DCI 16/18	2440	365314KH0B	ENE-24
i4752	BIELETA PASAJE DE CAMBIOS PEUGEOT 207 - HOGGAR (CAJA MA) CHASIS 1148077/..	80	2454G8	ENE-24
i4753	BIELETA PASAJE DE CAMBIOS CITROEN XSARA - XSARA PICASSO	90	245286	ENE-24
i4754	BIELETA SELECCIÓN DE CAMBIOS CITROEN BERLINGO - PEUGEOT PARTNER - (CAJA BE4R)	115	2454F5	ENE-24
i4755	BIELETA SELECCIÓN DE CAMBIOS PEUGEOT 206 - 207 - HOGGAR (CAJA BE4R)	120	2454G4	ENE-24
i4756	BIELETA SELECCIÓN DE CAMBIOS PEUGEOT 206- 207 - HOGGAR (CAJA MA)	160	2454G5	ENE-24
i4757	BIELETA PASAJE DE CAMBIOS CITROEN BERLINGO - PEUGEOT PARTNER - 206 - 207 - HOGGAR - (CAJA BE4R)	280	245281	ENE-24
i4758	EMBRAGUE REGULACION AUTOMATICA C/CONTRAPESO CITROEN BERLINGO 1.4 N (75 CV) - 1.6 16v (110 CV) - 1.6 HDI (90 CV) 10/16 - PEUGEOT PARTNER 1.4 N (75 CV) - 1.6 16v (110 CV) - 1.6 HDI (90 CV) 10/16	880	9825669080	AG-22
i4759	EMBRAGUE REGULACION MANUAL SIN CONTRAPESO CITROEN BERLINGO 1.4 N (75 CV) - 1.6 16v (110 CV) - 1.6 HDI (90 CV) 10/16 - PEUGEOT PARTNER 1.4 N (75 CV) - 1.6 16v (110 CV) - 1.6 HDI (90 CV) 10/16	940	ADAPT. 9825669080 - 9837204380	ENE-23
i4766	BIELETA PEDAL DE EMBRAGUE CITROEN BERLINGO - PEUGEOT 306 - PARTNER	-	212822	ENE-23
i4768	FRENO TRAS/DER. A CAMPANA FIAT PULSE 1.3 DRIVE - 1.0T IMPETUS 22/..	1620	52156077	ENE-23
i4769	FRENO TRAS/IZQ. A CAMPANA FIAT PULSE 1.3 DRIVE - 1.0T IMPETUS 22/..	1650	52156078	ENE-23
i4770	FRENO TRAS/DER-IZQ. A DISCO VW VENTO 11/18	1625	5C0609721BC	ENE-23
i4771	FRENO DEL. A CAMPANA CHEVROLET SONIC 12/.. - COBALT 13/..	185	95229769 - 95937512	ENE-23
i4772	FRENO DEL. TOYOTA COROLLA 08/14	320	4641002160 - 4641002170	ENE-23
i4776	CAMBIO VELOCIDADES FIAT PULSE IMPETUS 1.0 - 1.3 DRIVE 1.3	1215	52150088	ENE-24
i4777	FRENO DELANTERO NISSAN FRONTIER 2.3 DCI 18/.. - RENAULT ALASKAN 2.3 DCI 20/..	555	364024KD0B	ENE-24
i4778	FRENO TRASERO DERECHO NISSAN FRONTIER 2.3 DCI 18/.. - RENAULT ALASKAN 2.3 DCI 20/..	2180	365305JL0A	ENE-24



LISTA DE NOVEDADES

Código	Aplicación	Largo	Nº OEM	Incorp
i4779	FRENO TRASERO IZQUIERDO NISSAN FRONTIER 2.3 DCI 18/.. - RENAULT ALASKAN 2.3 DCI 20/..	2490	365315JL0A	ENE-24
i4781	FRENO TRASERO DERECHO NISSAN VERSA MOTOR 1.6 (107 CV) 13/20	1835	365303BA0A	ENE-24
i4782	FRENO TRASERO IZQUIERDO NISSAN VERSA MOTOR 1.6 (107 CV) 13/20	1825	365313BA0A	ENE-24
i4785	FRENO TRASERO DER/IZQ A CAMPANA 14/.. RENAULT LOGAN - SANDERO	1730	365306778R	MAY-23
i4811	FRENO TRASERO A DISCO C/ABS - 2 CABLES C/CHAPA UNION CHEVROLET VECTRA - CALIBRA 07/..	3220	93344545	AGO-24



DEPOSITOS PARA LIQUIDO DE FRENOS



Código	Imagen	Descripción	Incorp.
K4032		DEP. LIQUIDO FRENO SIN TAPA CHEVROLET CORSA	ABR-24

Código	Imagen	Descripción	Incorp.
K4092		PLATO TRASERO CHEVROLET SILVERADO 97/.. // 12" // DER/IZQ.	AGO-24



CAÑOS DE COBRE Y CONEX. DE BRONCE



Cód.	Med.	Aplicación	Ilustración	Incorp.
M10107	-	DERIVADOR FORD RANGER 10x1 CON CONO (CHAPA)		MAY-24
M10108	-	DERIVADOR FORD RANGER 10x1 CON CONO (BLOQUE)		MAY-24



DISCOS Y CAMPANAS



DISCOS DE FRENO											
Cód.	Aplicación	Año	D T	S V	A mm	B mm	C mm	D mm	D Min. mm	E	Incorp.
AUDI											
N3322	AUDI Q5 2.0 / 3.0 TFSI QUATTRO 16/.. - Q7 3.0 TDI QUATTRO / TFSI QUATTRO 17/.. - SQ5 3.0 TFSI QUATTRO 17/..	VER	D	V	349,0	57,0	68,0	34,0	32,0	5	AGO-24



LISTA DE NOVEDADES

DISCOS DE FRENO

Cód.	Aplicación	Año	D T	S V	A mm	B mm	C mm	D mm	D Min. mm	E	Incorp.
------	------------	-----	--------	--------	---------	---------	---------	---------	--------------	---	---------

AUDI - cont.

N3625	AUDI A4 2.0 TFSI 16/.. - A4 AVANT 2.0 TFSI 16/20 - A5 SPORTBACK 2.0 17/18	VER	D	V	318,0	57,0	68,0	30,0	28,0	5	DIC-24
--------------	---	-----	---	---	-------	------	------	------	------	---	--------

BMW

N0060	BMW SERIE 3 G20 330 I 19/.. - X3 G01 XDRIVE30I 19/.. - X4 G02 XDRIVE30I 18/.. EJE DERECHO	VER	T	V	330,0	64,0	67,0	20,0	18,4	5	AGO-24
N0061	BMW SERIE 3 G20 330 I 19/.. - X3 G01 XDRIVE30I 19/.. - X4 G02 XDRIVE30I 18/.. EJE IZQUIERDO	VER	T	V	330,0	64,0	67,0	20,0	18,4	5	AGO-24
N0065	BMW X2 XDRIVE M35I 20/.. - SERIE 1 135I M DRIVE 19/22	VER	T	V	330,0	50,7	67,0	20,0	18,4	5	AGO-24
N0087	BMW SERIE 3 G20 330I 19/.. - X3 G01 XDRIVE30I 19/.. - X4 G02 XDRIVE30I 18/..	VER	D	V	330,0	66,0	67,0	24,0	22,4	5	AGO-24
N3579	BMW SERIE 2 21/.. - SERIE 3 20/.. - SERIE 4 21/.. - SERIE 5 20/.. - SERIE 6 20/.. - SERIE 7 19/.. EJE IZQUIERDO	VER	D	C	374,0	66,0	67,0	36,0	34,0	5	AGO-24
N3580	BMW SERIE 2 21/.. - SERIE 3 20/.. - SERIE 4 21/.. - SERIE 5 20/.. - SERIE 6 20/.. - SERIE 7 19/.. EJE DERECHO	VER	D	V	374,0	66,0	67,0	36,0	34,0	5	AGO-24

CHEVROLET

N1573	CHEVROLET TRACKER 1.2 T LTZ 21/23 - 1.2 T Premier 21/23 - MONTANA 1.2 T LTZ 23/.. - 1.2 T Premier 23/..	VER	D	V	276,0	45,6	60,0	26,0	23,0	5	DIC-24
--------------	---	-----	---	---	-------	------	------	------	------	---	--------

GREAT WALL

N9059	GREAT WALL WINGLE 7	21/..	D	V	280,0	36,0	88,0	26,0	24,6	6	DIC-24
--------------	---------------------	-------	---	---	-------	------	------	------	------	---	--------

FORD

N0298	FORD TERRITORY 1.5	20/23	D	V	292,0	50,2	65,0	26,0	24,0	5	DIC-24
N0299	FORD TERRITORY 1.5	20/23	T	S	301,5	38,6	65,0	12,0	10,0	5	DIC-24
N4029	FORD RANGER 3.0 TDI 06/12; 2.8 TDI 01/06; 4.0 V6 98/99; 2.5 MPI 97/01; 2.5 TDI 98/02; 2.8 TDI 04/06 - EXPLORER 4.0 93/02	VER	D	V	286,5	108,2	45,2-65	26,0	24,5	5	NOV-24
N4159	FORD MAVERICK 2.0 16V TURBO 21/.. - MAVERICK 2.5 HYBRID 22/..		T	S	302,0	41,0	63,5	11,0	9,0	5	JUN-24
N4160	FORD MAVERICK 2.0 16V TURBO 21/.. - MAVERICK 2.5 HYBRID 22/..	VER	D	V	325,0	50,5	63,5	27,0	25,0	5	JUN-24
N7340	FORD S-MAX 2.0 GDTI / ECOBOOST AT	17/..	T	S	316,0	50,9	63,6	11,0	9,5	5	JUN-24
N7914	FORD RANGER RAPTOR 2.0L	19/..	D	V	332,0	59,0	98,0	32,0	30,0	6	DIC-24
N7915	FORD RANGER RAPTOR 2.0L	19/..	T	V	332,0	80,6	93,0	24,0	22,0	6	DIC-24





LISTA DE NOVEDADES

DISCOS DE FRENO

Cód.	Aplicación	Año	D T	S V	A mm	B mm	C mm	D mm	D Min. mm	E	Incorp.
------	------------	-----	--------	--------	---------	---------	---------	---------	--------------	---	---------

LAND ROVER

N7384	LAND ROVER DISCOVERY V 16/.. - RANGE ROVER IV 17/.. - RANGE ROVER SPORT II 16/..	VER	T	V	325,0	49,0	79,0	25,0	23,0	5	AGO-24
N9993	LAND ROVER DISCOVERY V 2.0, 3.0 16/.. - RANGE ROVER IV 2.0, 3.0 17/.. - RANGE ROVER SPORT II 2.0 16/.. - RANGE ROVER SPORT II 3.0 17/..	VER	D	V	349,0	62,0	79,0	34,0	32,0	5	AGO-24

LEXUS

N4428	LEXUS RX350 3.5	21/..	D	V	328,0	39,5	62,0	18,0	16,5	5	DIC-24
--------------	-----------------	-------	---	---	-------	------	------	------	------	---	--------

MERCEDES BENZ

N0217	MB A220 - B220 18/.. - MB A200 - CLA220 - GLB180 - GLB200 19/.. - MB CLA250 - GLA180 - GLA200 20/..		D	V	318,0	51,0	67,0	30,0	27,4	5	JUN-24
N0218	MB CLASE A - CLASE B 18/.. MB CLA - GLB 19/.. - MB GLA 20/.. - MB EQA - EQB 21/..		T	S	320,0	44,0	67,0	12,0	10,3	5	JUN-24
N0219	MB CLASE A - CLASE B 18/.. - MB CLA - GLB 19/.. - MB GLA 20/..		T	S	295,0	44,0	67,0	12,0	10,3	5	JUN-24
N0130	MB GLE 450 4MATIC	20/..	D	V	375,0	60,0	37,0	36,0	33,4	5	JUN-24
N0131	MB GLE 450 4MATIC - GLE 53 AMG 4MATIC 20/.. - MB GLE 63 AMG S 4MATIC 21/..		T	V	345,0	54,0	67,0	22,0	19,4	5	JUN-24
N0126	MB GLE 450 4MATIC (PERFORADO)	20/..	D	V	375,0	59,5	67,0	36,0	34,0	5	JUN-24
N0129	MB GLE 53 AMG 4MATIC - GLE 63 AMG 4MATIC (PERFORADO)	19/..	D	V	400,0	60,0	67,0	38,0	36,0	5	JUN-24
N0204	MB SPRINTER 2.2 CDI 116CV 12/24 - SPRINTER 2.2 CDI 150CV 16/24	VER	T	S	298,0	71,2	85,0	18,0	16,0	6	NOV-24

MINI

N0065	MINI COUNTRYMAN 4 2.0 19/20 - MINI CLUBMAN 4 2.0 19/..	VER	T	V	330,0	50,7	67,0	20,0	18,4	5	AGO-24
--------------	--	-----	---	---	-------	------	------	------	------	---	--------

NISSAN

N2089	NISSAN X-TRAIL III 2.5 CVT	18/..	D	V	296,0	44,0	68,0	26,0	24,0	5	DIC-24
N7313	NISSAN X-TRAIL III 2.5 CVT - NISSAN LEAF II Eléctrico	18/..	T	V	292,0	47,0	68,0	16,0	14,0	5	DIC-24

PEUGEOT

N4756	PEUGEOT 208 GT 1.2 T	20/..	T	S	249,0	35,0	71,0	10,0	8,0	4	DIC-24
--------------	----------------------	-------	---	---	-------	------	------	------	-----	---	--------

PORSCHE

N3334	PORSCHE 718 BOXSTER PERFORADO 06/17 - CAYMAN PERFORADO 06/13		T	V	299,0	67,0	98,0	20,0	18,0	5	JUN-24
--------------	--	--	---	---	-------	------	------	------	------	---	--------



LISTA DE NOVEDADES

DISCOS DE FRENO

Cód.	Aplicación	Año	D T	S V	A mm	B mm	C mm	D mm	D Min. mm	E	Incorp.
------	------------	-----	--------	--------	---------	---------	---------	---------	--------------	---	---------

RAM

N5853	RAM 1500 5.7 V8 19/.. - 1500 REBEL 5.7 V8 23/..	VER	D	V	378,0	67,5	65,5	30,0	28,4	6	DIC-24
N5854	RAM 1500 5.7 V8 19/.. - 1500 REBEL 5.7 V8 23/..	VER	T	V	375,0	53,5	78,5	22,0	20,4	6	DIC-24

RENAULT

N2089	RENAULT KOLEOS II 2.5 CVT	18/..	D	V	296,0	44,0	68,0	26,0	24,0	5	DIC-24
N7313	RENAULT KOLEOS II 2.5 CVT	18/..	T	V	292,0	47,0	68,0	16,0	14,0	5	DIC-24

SUBARU

N6772	SUBARU FORESTER 2.0 AWD CVT XS - 2.5 AWD CVT	18/..	T	V	285,0	46,5	58,0	17,0	15,0	5	JUN-24
-------	--	-------	---	---	-------	------	------	------	------	---	--------

SUZUKI

N6035	SUZUKI SWIFT 1.5L	07/11	D	V	252,0	40,0	60,0	20,0	18,5	8	NOV-24
-------	-------------------	-------	---	---	-------	------	------	------	------	---	--------

TOYOTA

N4118	TOYOTA HILUX 2.8TDI AT - SW4 2.8TDI AT	20/..	D	V	319,0	67,5	108,0	38,0	25,0	6+2	ABR-24
N4137	TOYOTA COROLLA CROSS 1.8 HV ECVT HYBRID - COROLLA CROSS 2.0 16V DOHC CVT	21/..	D	V	305,0	49,5	62,0	28,0	25,0	5	AGO-24
N4146	TOYOTA HIACE	19/..	T	V	320,0	83,0	77,0	22,0	20,0	6	AGO-24
N4148	TOYOTA HIACE	19/..	D	V	296,0	61,0	77,0	38,0	35,0	6	AGO-24
N4428	TOYOTA CAMRY 2.5 HYBRID 21/.. - RAV4 2.0 - 2.5 13/.. - 2.5 HYBRID 19/.. - HIGHLANDER 3.5 07/..	VER	D	V	328,0	39,5	62,0	18,0	16,5	5	DIC-24
N5471	TOYOTA COROLLA CROSS 1.8 HV ECVT HYBRID - COROLLA CROSS 2.0 16V DOHC CVT	21/..	T	S	281,0	53,5	62,0	10,0	8,5	5	AGO-24

VOLKSWAGEN

N5647	VW VENTO 250 TSI 18/20 - TAOS 250 TSI 21/..		T	S	272,0	58,0	65,0	10,0	9,0	9	JUN-24
-------	---	--	---	---	-------	------	------	------	-----	---	--------



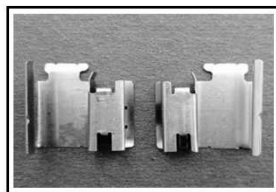

P1584

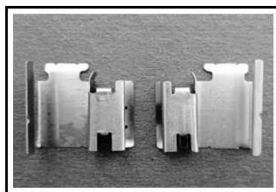

P1585

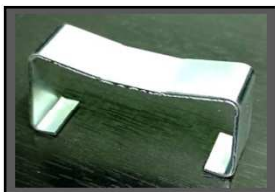

P1599



P1608



P1609



P1610



P1611



P1625



P1626

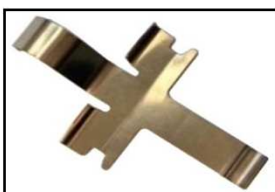

P1630



P1632



P1633

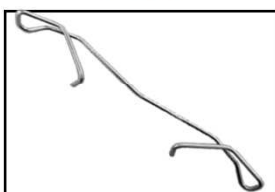

P2154



P2228A

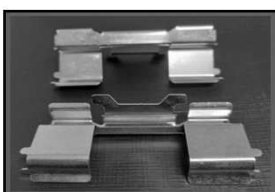

P2230A



P2233A



P2284A



P2285A



P2520T



P2521T



P2522T



P2523T

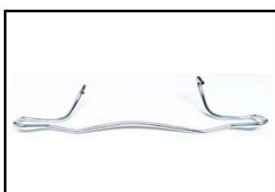

P2650

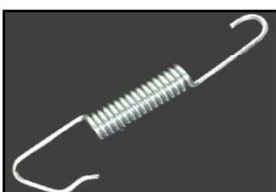

P2828



P2828/1

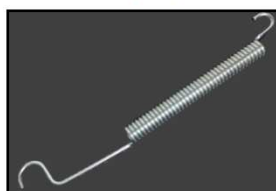

P2829



P2832

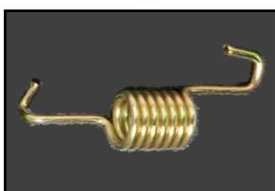

P2833

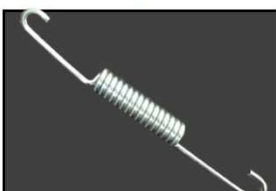

P2834



P2835



P7203



P9107



P9108



P9109



P9110



LISTA DE NOVEDADES



P9111



P9112



P22230



P22598

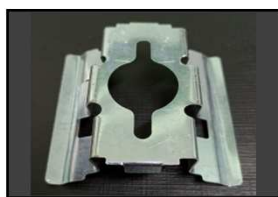

P42337

Código	Marca	Descripción	Incorp.
P1584	CITR. - PEUG. - VW	ANTIRRUIDO DER/IZQ. CITROEN C4 VTS - C4 // PEUG. 307 // VW AMAROK - BOSCH (NVA. APLICACIÓN)	SEP-23
P1585	CITR. - PEUG. - VW	ANTIRRUIDO DER/IZQ. CITROEN C4 VTS - C4 // PEUG. 307 // VW AMAROK - BOSCH (NVA. APLICACIÓN)	SEP-23
P1599	IVECO	TRABA P/TAMBOR DCO. TRASERO IVECO TURBO DAILY TRAS/DER-IZQ LGO. 32,6mm - ANCHO 9mm - ESP. 0,8mm	DIC-24
P1608	TOYOTA	JGO. LEVA IZQUIERDA TOYOTA HILUX 05/..	FEB-23
P1609	TOYOTA	JGO. LEVA DERECHA TOYOTA HILUX 05/..	FEB-23
P1610	IVECO	JGO. LEVA IVECO (TODOS)	MAR-23
P1611	CITR. - FIAT - PEUG.	JGO. LEVA CITROEN JUMPER - FIAT DUCATO - PEUGEOT BOXER 01/17	SEP-23
P1625	CHEVROLET	REGISTRO IZQUIERDO CHEVROLET ASTRA - CORSA II - MERIVA	FEB-23
P1626	CHEVROLET	REGISTRO DERECHO CHEVROLET ASTRA - CORSA II - MERIVA	FEB-23
P1630	TOYOTA	ANTIRRUIDO CALIPER DEL. DER/IZQ. TOYOTA HILUX - ACERO	MAY-24
P1632	IVECO	CON. ANCLAJE P/TAMBOR DCO. TRASERO IVECO TURBO DAILY LGO. CLAVO 45,9mm - LGO. E/CABEZAS 41mm - Ø 4mm - LGO. SEGURO 24,5mm - ANCHO SEGURO 13mm	DIC-24
P1633	FORD	PERNO PARA GATILLO FORD RANGER	SEP-23
P2154	FIAT	SOPORTE CALIPER FIAT CRONOS - ARGO	SEP-24
P2228A	CHEVROLET	KIT ANTIRRUIDO CHEVROLET S10 4x2 - 4x4 12/16	MAY-24
P2230A	IVECO	KIT ANTIRRUIDO PAST. IVECO 70C16, 70C17, 35S14 ECONOLINE CD	MAY-24
P2233A	HYUNDAI	KIT ANTIRRUIDO PAST. HYUNDAI HR DEL.	MAY-24
P2284A	KIA	KIT ANTIRRUIDO CALIPER KIA BONGO, K2700, K2500 ../12 - K2400 ../00	MAY-24
P2285A	FIAT	KIT ANTIRRUIDO CALIPER FIAT DUCATO 16" C/ABS	MAY-24
P2520T	FORD	TUERCA FORD FOCUS RCA. 10x1,5 - LARGO 17,5mm	MAY-24
P2521T	FORD	TUERCA FORD FOCUS RCA. 12x1,5 - P/CAÑO 3/16" - LARGO 17,5mm	MAY-24
P2522T	FORD	TUERCA FORD FOCUS RCA. 12x1,5 - P/CAÑO 1/4" - LARGO 17,5mm	MAY-24
P2523T	FORD - TOYOTA	TUERCA FORD RANGER - TOYOTA - RCA. 10x1 - LARGO 16mm	MAY-24
P2650	VW	TRABA PASTILLA VW BORA - GOL - PASSAT - VENTO	ENE-23
P2828	CITROEN	RESORTE ZAPATA CITROEN C3 - LUCAS	AGO-24
P2828/1	CITROEN	RESORTE GATILLO CITROEN C3 - LUCAS	AGO-24
P2829	CITROEN	RESORTE ZAPATA CITROEN C3 - LUCAS	AGO-24
P2832	CITROEN	RESORTE ZAPATA CITROEN C3 // DERECHO - BOSCH	AGO-24
P2833	CITROEN	RESORTE ZAPATA CITROEN C3 // IZQUIERDO - BOSCH	AGO-24
P2834	CITROEN	RESORTE ZAPATA CITROEN PICASSO 08/.. - LUCAS	AGO-24
P2835	CITROEN	RESORTE ZAPATA CITROEN PICASSO 08/.. - LUCAS	AGO-24
P7203	MITSUBISHI	KIT ANTIRRUIDO DELANTERO MITSUBISHI L200, TRITON 12/20	MAY-24
P9107	FIAT - FORD	REGULADOR IZQUIERDO FIAT QUBO - FORD ECOSPORT	MAR-23
P9108	FIAT - FORD	REGULADOR DERECHO FIAT QUBO - FORD ECOSPORT	MAR-23
P9109	IVECO	REGISTRO IVECO 60.13 - 70.13V 8.5TN	MAR-23
P9110	FIAT	REGISTRO FIAT DUCATO R15/16 (TODOS)	MAR-23
P9111	MITSUBISHI	REGISTRO DERECHO MITSUBISHI MONTERO 89/95	MAR-23
P9112	MITSUBISHI	REGISTRO IZQUIERDO MITSUBISHI MONTERO 89/95	MAR-23





LISTA DE NOVEDADES

Código	Marca	Descripción	Incorp.
P22230	FIAT - JEEP	KIT ANTIRRUIDO DELANTERO FIAT TORO - JEEP RENEGADE, COMPASS 16/21	MAY-24
P22598	VW	KIT ANTIRRUIDO VW BORA, GOLF, NEW BEETLE, PASSAT, VENTO, ETC	MAY-24
P42337	CITROEN - FIAT - PEUGEOT - TOYOTA	ANTIRRUIDO CALIPER TRASERO CITROEN JUMPER - FIAT DUCATO - PEUGEOT BOXER - TOYOTA YARIS	MAY-24





LISTA DE NOVEDADES



CILINDROS DE FRENO

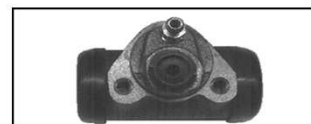



Q

Cód.	Aplicación	Año	Med	Sist.	Ubic.	Imagen	Inc.
Q454	CIL. RDA. FORD FOCUS III	07/14	13/16"	-	TRAS		ABR-23
Q4047	CIL. RDA. NISSAN PRIMERA RCA.: 10x1	66/..	13/16"	BX	D/I		DIC-24
Q4098	CIL. RDA. SUZUKI SWIFT III RCA.: 10x1	05/..	3/4"	BOSCH	D/I		DIC-24
Q4191	CIL. RDA. JEEP CHEROKEE CLASSIC 2.5TD 96/.. - CLASSIC 4.0 AT 95/.. - WRANGLER 2.5 88/.. RCA.: 3/8"	VER	7/8"		T/IZQ.		DIC-24
Q4192	CIL. RDA. JEEP CHEROKEE CLASSIC 2.5TD 96/.. - CLASSIC 4.0 AT 95/.. - WRANGLER 2.5 88/.. RCA.: 3/8"	VER	7/8"		T/DER		DIC-24
Q5801L	CIL. RDA LPR 4508 RENAULT 12 89/.. - 18 81/..	VER	7/8"	-	TRAS		JUL-24
Q6511L	CIL. RDA LPR 4066 PEUGOT P206 Con Válvula CONEXIÓN 12x1		3/4"	BOSCH	TRAS IZQ		JUL-24
Q6512L	CIL. RDA LPR 4067 PEUGEOT P206 Con Válvula CONEXIÓN 12x1		3/4"	BOSCH	TRAS DER		JUL-24
Q7101DL	CIL. RDA. LPR 4130 CHEVROLET 400 68/74 FD DIESEL - CHEVY // FORD F100 59/84 - F150 - FALCON - FAIRLANE 69/..		7/8"	BX	TRAS DER		JUL-24



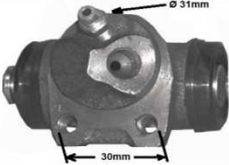

LISTA DE NOVEDADES

Cód.	Aplicación	Año	Med	Sist.	Ubic.	Imagen	Inc.
Q7101L	CIL. RDA. LPR 4129 CHEVROLET 400 68/74 FD DIESEL - CHEVY // FORD F100 59/84 - F150 - FALCON - FAIRLANE 69/..		7/8"	BX	TRAS IZQ		JUL-24
Q8501L	CIL. RDA. LPR 4920 FORD ESCORT - FIESTA CLX - KA 87/.. CONEXIÓN 10x1	-	11/16"	VARGA	TRAS		JUN-24
Q9701L	CIL. RDA. LPR 4537 R-9 / R- 11 / R-19 / CLIO CONEXIÓN 10x1	-	22mm	BX	TRAS IZQ		JUN-24
Q9701DL	CIL. RDA. LPR 4535 R-9 / R- 11 / R-19 / CLIO CONEXIÓN 10x1	-	22mm	BX	TRAS DER		JUN-24
Q9801L	CIL. RDA. LPR 4452 FIAT DUNA - UNO - REGATTA RCA: 10x1		3/4"	VARGA	TRAS		JUL-24
Q9901L	CIL. RDA. LPR 4913 VOLKSWAGEN CARAT - GACEL - GOL - PASSAT - SANTANA - SENDA	-	9/16"	VARGA	TRAS		JUN-24
Q9905	CIL. RDA. FIAT DOBLO - 500 // VW POLO - T-CROSS	17/..	13/16"	-	TRAS		ABR-23
Q9906	CIL. RDA. VW NVO POLO RCA: 10x1	18/..	3/4"	-	TRAS		ABR-23
Q10111	CIL. RDA. NISSAN FRONTIER RCA: 10x1 C/CONO	-	1"	-	TRAS		ABR-23
Q10112	CIL. RDA. NISSAN SENTRA	-	5/8"	-	TRAS		ABR-23











LISTA DE NOVEDADES

Cód.	Aplicación	Año	Med	Sist.	Ubic.	Imagen	Inc.
Q10113	CIL. RDA. NISSAN KICKS - VERSA	16/23	3/4"	-	T/IZQ		NOV-23
	RCA: 10x1 C/CONO						
Q10114	CIL. RDA. NISSAN KICKS - VERSA	16/23	3/4"	-	T/DER		NOV-23
	RCA: 10x1 C/CONO						
Q18002	CIL. RDA. HONDA CIVIC CRV - CRX	-	13/16"	-	T/IZQ		JUN-23
Q18003	CIL. RDA. HONDA CIVIC CRV - CRX	-	13/16"	-	T/DER		JUN-23
Q18004	CIL. RDA. HONDA CIVIC CRV - CRX	-	3/4"	-	T/IZQ		JUN-23
Q18005	CIL. RDA. HONDA CIVIC CRV - CRX	-	3/4"	-	T/DER		JUN-23
Q18006	CIL. RDA. HONDA CITY - FIT	-	3/4"	-	TRAS		JUL-23
Q31201	VÁLV. LIMITADORA NISSAN VERSA - TIIDA	-	-	-	-		ABR-24
Q31301	VÁLV. LIMITADORA FIAT DOBLO	-	-	-	-		SEP-24
Q80201L	CIL. RDA. LPR 4259 FORD ESCORT 16v - DIESEL 98/... FOCUS I 98/10 - ORION 16 V	-	13/16"	TENSA	TRAS		SEP-24
	CONEXIÓN 10x1						

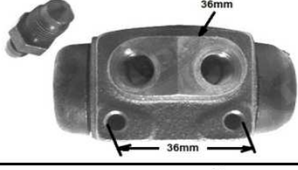
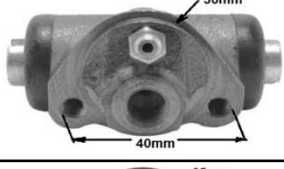
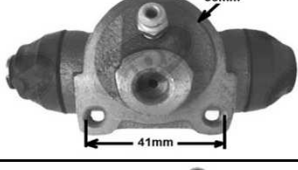

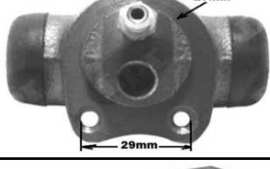
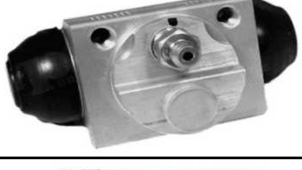
LISTA DE NOVEDADES

Cód.	Aplicación	Año	Med	Sist.	Tipo	Imagen	Inc.
Q80501DL	CIL. RDA LPR 4583 DERECHO CITROEN XSARA - ZX // PEUGEOT 206 - 306 // RENAULT 19 - CLIO (CON VALVULA) CONEXIÓN 12x1		13/16"	BX	TRAS DER		SEP-24
Q80501iL	CIL. RDA. LPR 4582 IZQUIERDO CITROEN XSARA - ZX // PEUGEOT 206 - 306 // RENAULT 19 - CLIO (CON VALVULA) CONEXIÓN 12x1		13/16"	BX	TRAS IZQ		SEP-24
Q81001L	CIL. RDA LPR 4258 FORD ESCORT - FIESTA - FOCUS - ORION // VW POINTER CONEXIÓN 10x1	-	3/4"	VARGA	TRAS		JUN-24
Q81601L	CIL. RDA. LPR 4475 FIAT DUNA - UNO - REGATTA - 147 Autorregulable RCA: 10x1	-	3/4"	VARGA	TRAS		JUL-24
Q82601L	CIL RDA. LPR 4484 FIAT PALIO - SIENA - TEMPRA - FIORUNO CONEXIÓN 10x1	-	13/16"	ATE	TRAS		JUN-24
Q82901L	CIL. RDA. LPR 4912 - FORD GALAXY // SEAT CORDOBA // VW POLO - SAVEIRO - SURAN - FOX - GOLF - QUANTUM	-	11/16"	ATE	TRAS		JUN-24
Q84301L	CIL. RDA. LPR 4248 - CHEVROLET ASTRA - CORSA - VECTRA	-	3/4"	VARGA	TRAS		JUN-24
Q84303L	CIL. RDA. LPR 4494 CHEVROLET AVEO CONEXIÓN M10x1	08/..	3/4"	-	TRAS		SEP-24
Q84308L	CIL. RDA. LPR 5225 CHEVROLET COBALT - ONIX - PRISMA - SONIC CONEXIÓN 10x1	-	3/4"		TRAS		AGO-24
Q84310	CIL. RDA.CHEVROLET ONIX	20/..	3/4"		TRAS		AGO-24



LISTA DE NOVEDADES

Cód.	Aplicación	Año	Med	Sist.	Tipo	Imagen	Inc.
Q84501L	CIL. RDA. LPR 4669 - PEUGEOT 504 PICK-UP T6B - RENAULT EXPRESS CONEXIÓN 10x1	-	7/8"	-	TRAS		JUL-24
Q84901L	CIL. RDA. LPR 4489 FIAT PALIO - SIENA Base Triangular CONEXIÓN 10x1	-	3/4"	ATE	TRAS		JUL-24
Q85201L	CIL. RDA. LPR 4595 RENAULT MEGANE 1.6 1.9TD 2.0 CONEXIÓN 10x1	-	11/16"	BENDIX	TRAS		JUL-24
Q85401L	CIL. RDA. LPR 4876 CITROEN BERLINGO // PEUGEOT PARTNER	-	7/8"	LUCAS	TRAS		JUN-24
Q85801L	CIL. RDA. LPR 4696 RENAULT CLIO II CONEXIÓN 10x1	-	11/16"	-	TRAS		JUL-24
Q85802L	CIL. RDA. LPR 4078 RENAULT CLIO - CLIO II M/N - LOGAN - SANDERO - SANDERO STEPWAY - SYMBOL // VW UP	-	11/16"	-	TRAS		JUL-24
Q85810	CIL. RDA. RENAULT KWID	17/..	5/8"	-	TRAS		ABR-23
Q85811	CIL. RDA. RENAULT ALASKAN 2.3 DCI 4x4	-	7/8"	-	TRAS		ABR-24
Q85901L	CIL. RDA. LPR 4028 RENAULT KANGOO	-	22mm	BOSH	TRAS	SIN IMAGEN	SEP-24
Q87901L	CIL. RDA. LPR 5168 FIAT PALIO - SIENA - STRADA (BASE RECTA)	-	3/4"	-	TRAS		SEP-24



LISTA DE NOVEDADES



**BBAS. EMBRAGUE, FRENO Y CIL.
AUX. NACIONAL - IMPORTADO**

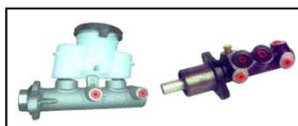

**QB
QR
QS**

Cód.	Aplicación	Año	Med	Sist.	Tipo	Imagen	Inc.
QB039	CRAPODINA HIDRAULICA DE EMBRAGUE MERCEDES BENZ 712 - 914 - 1215 - 1620 - ATEGO - AXOR	VER	23mm				DIC-22
QB040	CRAP. HIDR. EMBR. FORD KUGA 2.5T 09/14 - MONDEO 2.5T 07/14 // LAND ROVER FREELANDER II 2.2 DIESEL 06/..	VER	Ø 31mm				SEP-22
QB041	CRAPODINA HIDRAULICA DE EMBRAGUE (PLÁSTICO) CHEVROLET CRUZE 1.4T	16/..	Ø 27mm				SEP-22
QB042	CRAP. HIDR. EMBR. CITROEN C4 GRAND PICASSO 1.6 THP, 1.6 HDI - C4 LOUNGE 1.6 THP, 1.6 HDI 13/.. - DS3 1.6 THP - DS4 1.6 THP // PEUGEOT 208 1.6 THP - 308 1.6 THP, 1.6 HDI - 408 1.6 THP, 1.6 HDI - 2008 1.6 THP - 3008 1.6 THP	VER	Ø 24mm				SEP-22
QB043	CRAP. HIDR. EMBR. CITROEN C4 GRAND PICASSO 1.6 THP, 1.6 HDI - C4 LOUNGE 1.6 THP, 1.6 HDI 13/.. - DS3 1.6 THP - DS4 1.6 THP // PEUGEOT 208 1.6 THP - 308 1.6 THP, 1.6 HDI - 408 1.6 THP, 1.6 HDI - 2008 1.6 THP - 3008 1.6 THP	VER	Ø 23mm				SEP-22
QB044	CRAPODINA HIDRAULICA DE EMBRAGUE TOYOTA COROLLA 09/.. - ETIOS 16/..	VER	Ø 28mm				SEP-22
QB046	CRAPODINA HIDRAULICA DE EMBRAGUE (CAÑO LARGO) NISSAN TIIDA 08/.. - X-TRAIL 11/.. // RENAULT DUSTER 11/.. - FLUENCE 10/.. - KOLEOS 09/.. - MEGANE III 11/..	VER	5/8"				AG-22
CONEXIÓN: ENCHUFAR							
QB055	CRAPODINA HIDRAULICA DE EMBRAGUE FIAT TORO 16/.. - TORO 2.0 // JEEP COMPASS 17/.. - RENEGADE 16/..	VER	23mm				DIC-22



LISTA DE NOVEDADES

Cód.	Aplicación	Año	Med	Sist.	Tipo	Imagen	Inc.
QB2334	BOMBA DE EMBRAGUE CHEVROLET AVEO (VARIOS MODELOS) <i>RCA.: 10x1</i>	-	5/8"				DIC-24
QB3073	CAE CITROEN C-ELYSEE - C3 II 09/.. C4 CACTUS - DS3 // PEUGEOT 2008 - 207 EUROPEO 08/.. - 208 - 301 <i>CONEXIÓN: ENCHUFAR</i>	VER	3/4"				OCT-24
QB3110	BOMBA DE EMBRAGUE HYUNDAI TUCSON // KIA SPORTAGE	10/..	5/8"				SEP-22
QB6175	BOMBA DE FRENO RENAULT LOGAN II - SANDERO II <i>4 SALIDAS 10x1</i>	14/..	13/16"				NOV-24
QB10250	BOMBA DE EMBRAGUE TOYOTA COROLLA 09/.. - ETIOS 12/..	VER	5/8"				SEP-22
QB12300	BBA. EMBRAGUE NISSAN SENTRA 13/16 - TIIDA 07/15 - VERSA 13/15	VER	5/8"				JUL-23
QB12301	BBA. EMBRAGUE NISSAN MARCH 12/.. - NOTE 15/.. - VERSA 15/20	VER	5/8"				JUL-23
QB13610	BBA. EMBRAGUE (CAJA AUTOMÁTICA EASYTRONIC) CHEVR. CORSA II - MERIVA	03/..					SEP-22
QB13611	BBA. EMBRAGUE CHEVROLET CRUZE 1.4 TURBO <i>CONEXIÓN: ENCHUFAR</i>	16/..	5/8"				SEP-23
QB15605	BOMBA DE EMBRAGUE FORD ECOSPORT 12/17 - ECOSPORT 17/.. - FIESTA KINETIC 10/.. <i>CONEXIÓN: ENCHUFAR</i>	VER	5/8"				SEP-22





LISTA DE NOVEDADES

Cód.	Aplicación	Año	Med	Sist.	Tipo	Imagen	Inc.
QB17103	BBA. EMBRAGUE SUZUKI SWIFT	08/..	5/8"				AG-22
	CONEXIÓN: ENCHUFAR						
QB17104	CILINDRO AUXILIAR DE EMBRAGUE SUZUKI SWIFT	08/..	13/16"				AG-22
	CONEXIÓN: ENCHUFAR						
QB17203	BBA. EMBRAGUE SUZUKI GRAND VITARA JIII	08/..	5/8"				AG-22
	CONEXIÓN: ENCHUFAR						
QB19100	BBA. EMBRAGUE DODGE JOURNEY 08/.. // JEEP COMPASS 06/.. - PATRIOT 07/..	VER	11/16"				AG-22
	CONEXIÓN: ENCHUFAR						
QB23503	BBA. FRENO C/DEPOSITO VW GOL TREND SAVEIRO TREND MOTOR MSI	14/..	7/8"	DC			SEP-23
	CONEXIÓN 2 - 10x1 // 2 - 12x1						
QB24108	BOMBA DE EMBRAGUE NISSAN XTRAIL 08/14 // RENAULT KOLEOS 09/15	VER	5/8"				SEP-22
	CONEXIÓN: ENCHUFAR						
QB24109	BOMBA DE EMBRAGUE RENAULT DUSTER - DUSTER OROCH	-	5/8"				SEP-22
	CONEXIÓN: ENCHUFAR						
QB24110	BBA. EMBRAGUE RENAULT LOGAN 13/.. - SANDERO 15/.. - STEPWAY 15/..	VER	5/8"				AG-22
	CONEXIÓN: ENCHUFAR						
QB24111	BBA. EMBRAGUE RENAULT FLUENCE - MEGANE II		5/8"				ENE-24
	CONEXIÓN: ENCHUFAR						
QB25104	BBA. EMBRAGUE FIAT TORO // JEEP RENEGADE		5/8"				JUL-23
	CONEXIÓN: ENCHUFAR						





LISTA DE NOVEDADES

Cód.	Aplicación	Año	Med	Sist.	Tipo	Imagen	Inc.
QB25105	BBA. EMBRAGUE FIAT LINEA - PUNTO	08/..	5/8"				AG-22
	<i>CONEXIÓN: ENCHUFAR</i>						
QB25106	BOMBA DE EMBRAGUE FIAT ARGO - CRONOS - GRAND SIENA - PALIO NOVO - UNO FASE II 10/..	-	5/8"				SEP-22
	<i>CONEXIÓN: ENCHUFAR</i>						
QB29101	BOMBA DE EMBRAGUE CITROEN C4 // PEUGEOT 307 - 308	-	5/8"				SEP-22
	<i>CONEXIÓN: ENCHUFAR</i>						
QB32101	BOMBA DE EMBRAGUE (ALUMINIO) CHERY TIGGO 1.6	08/16	5/8"				SEP-22
QB32102	BBA. EMBRAGUE (ALUMINIO + PLÁSTICO) CHERY TIGGO 2.0	08/16	3/4"				SEP-22
QB32103	CILINDRO AUXILIAR DE EMBRAGUE CHERY TIGGO	08/13	13/16"				SEP-22
	<i>CONEXIÓN: M10x1</i>						
QR4207	BBA. EMBR. FORD CARGO	11/..	1"				ABR-23
QR4208	BBA. EMBRAGUE FORD TRANSIT	00/06	5/8"				JUL-24
QR4401	CIL. AUX. EMBR. FORD TRANSIT	-	13/16"				JUL-24
QR4407	CIL. AUX. EMBR. FORD CARGO	-	1 1/8"				ABR-23





LISTA DE NOVEDADES

Cód.	Aplicación	Año	Med	Sist.	Tipo	Imagen	Inc.
QS0830	BBA. FRENO HONDA FIT	16/..	3/4"				NOV-24
	2 SAL. 10x1						
QS0831	BBA. FRENO HONDA CRV	07/..	7/8"				DIC-24
	2 SALIDAS 10x1						
QS1420	BBA. FRENO NISSAN SENTRA 2.6 - 2.0	11/14	15/16"				NOV-24
	2 SAL. 10x1						
QS2002	BBA. FRENO TOYOTA HILUX / SW4 2.3, 2.7, 3.0 MT/AT C/ESP.	11/15	7/8"				AGO-24
	2 SAL.: 10x1 C/CONO						
QS2003	BBA. FRENO DC TOYOTA HILUX - SW4 2.4 - 2.8	15/..	7/8"				NOV-23
	2 SAL.: 12x1 C/CONO						
QS2014	BBA. FRENO TOYOTA YARIS	15/..	13/16"				NOV-24
	2 SAL. 12x1 C/CONO						
QS2015	BBA. FRENO TOYOTA COROLLA	08/13	7/8"				NOV-24
	4 SAL. 10x1						
QS2016	BBA. FRENO TOYOTA COROLLA	08/13	7/8"				NOV-24
	4 SAL. 10x1 C/CONO						
QS06154	BBA. FRENO JEEP COMPASS	17/..	1"				NOV-24
	2 SAL. 12x1						
QS06268	BBA. FRENO FORD RANGER 2. TDCI - 2.5N - 3.2 TDCI 4x2 - 4x4 MT	12/16	7/8"				ENE-24
	2 SAL.: 10x1						



LISTA DE NOVEDADES

Cód.	Aplicación	Año	Med	Sist.	Tipo	Imagen	Inc.
QS06269	BBA. FRENO FORD RANGER 2.2TDCI - 2.5N - 3.2TDCI 4x2 - 4x4 MT 2 SAL.: 12x1	12/16	7/8"				MAR-24
QS06274	BBA. FRENO FORD FOCUS III - KUGA 2 SAL. 14x1	13/..	1"				NOV-24
QS07120	BBA. FRENO DC CHEVROLET S10 2.8 LS/LT/LTZ (MANUAL) 2 SAL.: 10x1	12/17	7/8"	BOSCH			ABR-23
QS07121	BBA. FRENO DC CHEVROLET S10 2.8 LS/LT/LTZ (AUTOMÁTICO) 2 SAL.: 12x1	12/17	7/8"	BOSCH			ABR-23
QS07150	BBA. FRENO CHEVROLET AVEO - SONIC - TRACKER 2 SAL. 10x1 C/CONO	14/..	15/16"				NOV-24
QS07151	BBA. FRENO CHEVROLET CAPTIVA 2 SAL. 12x1 C/CONO	13/..	1"				NOV-24
QS13115	BBA FRENO M. BENZ VITO 111 - FURGON 119 - COMBI 121 - TOURER C/ABS 2 SAL.: 12x1	15/..	1 1/16"	TRW			SEP-23
QS16214	BBA. FRENO CITROEN BERLINGO - XSARA // PEUGEOT 306 - PARTNER // (todos c/ABS) 2 SAL.: 10x1 - 12x1	97/15	15/16"	ATE			MAY-22
QS16244	BBA. FRENO PEUGEOT 208 (LINEA NUEVA) 2 SAL. 12x1	21/..	7/8"				NOV-24
QS18110	BBA. FRENO RENAULT CLIO II - KANGOO - KANGOO EXPRESS C/ABS 2 SAL.: 10x1 - 12x1	97/08	7/8"	BOSCH			JUN-22





LISTA DE NOVEDADES

Cód.	Aplicación	Año	Med	Sist.	Tipo	Imagen	Inc.
QS18158	BBA. FRENO RENAULT KWID	17/..	3/4"	BOSCH			AG-23
	2 SAL.: 10x1						
QS18159	BBA. FRENO RENAULT MEGANE II - SCENIC II		15/16"	-			MAY-23
	2 SAL.: 12x1						
QS18170	BBA. RENAULT DUSTER - OROCH	17/..	7/8"				NOV-24
	2 SAL. 10x1						
QS18171	BBA. FRENO NISSAN FRONTIER // RENAULT ALASKAN	16/..	1"				NOV-24
	2 SAL. 12x1						
QS18172	BBA. FRENO RENAULT LOGAN II - SANDERO II	15/..	13/16"				NOV-24
	2 SAL. 10x1						
QS18173	BBA. FRENO RENAULT CAPTUR - DUSTER - KANGOO II - LOGAN - SANDERO	18/..	7/8"				DIC-24
	2 SALIDAS 12x1						
QS21230	BBA. FRENO VW AMAROK 2.0TDI (ALUMINIO - SIN DEPOSITO)	10/16	1 1/16"				ENE-24
	2 SAL.: 12x1						
QS21231	BBA. FRENO CROSSFOX y FOX 10/22 // VW SURAN 11/19 // C/ABS		7/8"				OCT-24
	2 SAL.: 12x1						



LISTA DE NOVEDADES

(1254) RD12484M

CHEVROLET TRACKER 17/..

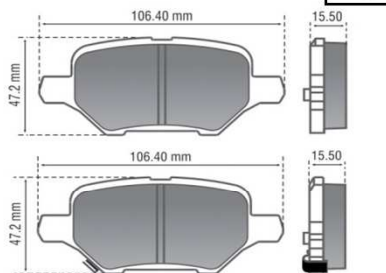

(1079) RD12485M

AUDI Q5 08/.. - A4 08/12 - A5 08/12

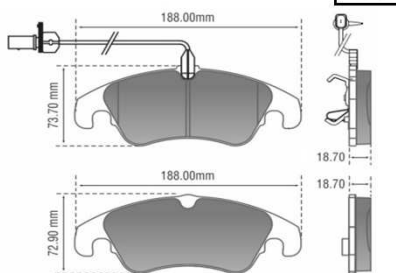

(1236) RD12486

CHEVROLET ONIX 1.0 TURBO 19/..

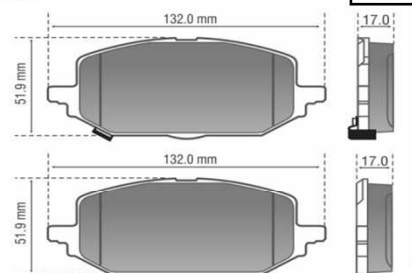

(1175) RD12488

KIA PICANTO 11/..

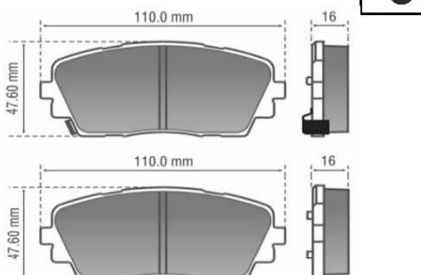

(0916) RD12495M

CITROEN JUMPY II 1.6 + 2.0 HDI 07/.. - SPACE TOURER 06/.. // FIAT SCUDO II 1.6 - 2.0 07/.. // PEUGEOT EXPERT 06/.. - EXPERT II TEPEE 1.6 - 2.0 07/..

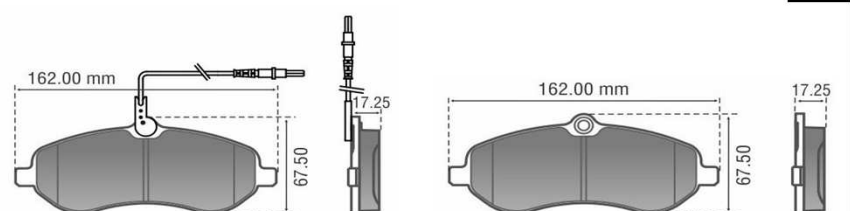

(0899) RD12497M

HYUNDAI CRETA 1.6 - 2.0 ATTITUDE - PULSE - PRESTIGE 16/.. - I30 - I30 CW 1.4 - 1.6 - 2.0 07/.. // KIA CARENS II EX LX- CRDI 1.6 - 1.8 - 2.0 02/.. CERATO 1.6 - 2.0 EX FORTE 10/.. - SOUL II 1.6 - 2.0 CVVT 14/..

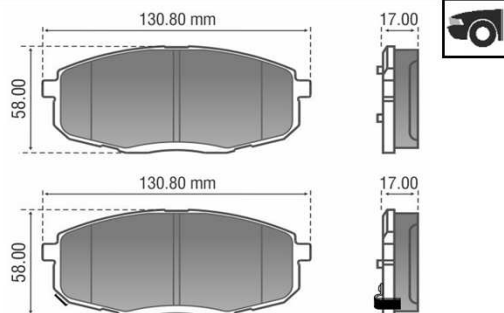

RD12498M

MERCEDES BENZ ACTROS 1841 14/17 - ACTROS 2531 13/14 - ACTROS 2636 12/14 - ACTROS 1841 LS 15/.. - ACTROS 1846 LS 15/.. - ACTROS 2041 S 11/.. - ACTROS 2042 S 18/.. - ACTROS 2044 S 11/14 - ACTROS 2046 S 13/.. - ACTROS 2048 LS 18/.. - ACTROS 2051 LS 18/.. - ACTROS 2645 LS 19/.. - ACTROS 2646 LS 19/.. - ACTROS 2646 S/LS 11/17 - ACTROS 2655 LS 17/..

RD12499M

MERCEDES BENZ ACTROS 1841 14/17 - ACTROS 2531 13/14 - ACTROS 2636 12/14 - ACTROS 1841 LS 15/.. - ACTROS 1846 LS 15/.. - ACTROS 2041 S 11/.. - ACTROS 2042 S 18/.. - ACTROS 2044 S 11/14 - ACTROS 2046 S 13/.. - ACTROS 2048 LS 18/.. - ACTROS 2051 LS 18/.. - ACTROS 2645 LS 19/.. - ACTROS 2646 LS 19/.. - ACTROS 2646 S/LS 11/17 - ACTROS 2655 LS 17/..

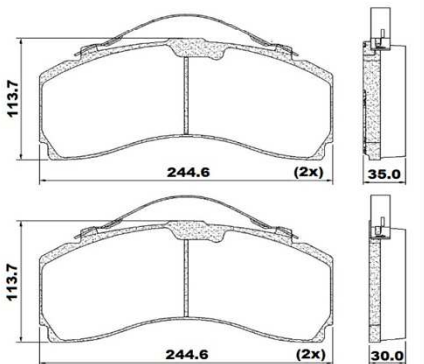
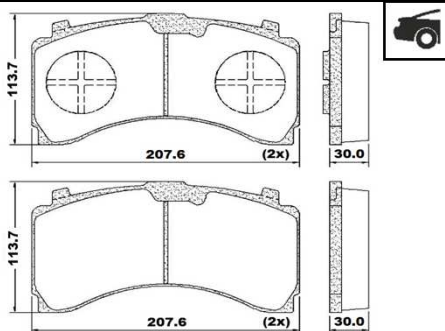

(0520) RD12500M

IVECO EURO RIDER 99/.. // M. BENZ ACTROS 1938 98/.. // SCANIA K-124 - 230 - 270 - 310 - 340 - 380 4x2 08/.. - SERIE 4 R144 LB 99/.. - SERIE 4 T124 6B 99/.. // KNORR

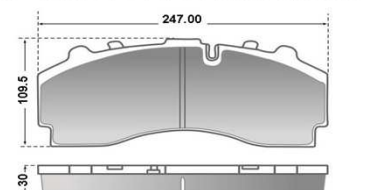

(1071) RD12506M

AUDI A3 II - S3 1.4 TSI - 1.8 - 2.0 TDI 12/.. - Q2 TFSI 2.0 QUATTRO 16/.. // SEAT ALHAMBRA II 1.4 TSI - 2.0 TDI 16V 4WD 10/.. // VW GOLF VII 1.4 TSI - 2.0 GTI 18/.. - PASSAT CC 2.0 TSI - 3.6 TFSI 08/.. - SHARAN II 1.4 TSI - 2.0 TDI 16V 4WD 10/.. - TIGUAN II 1.4 TSI - 2.0 TDI 17/..

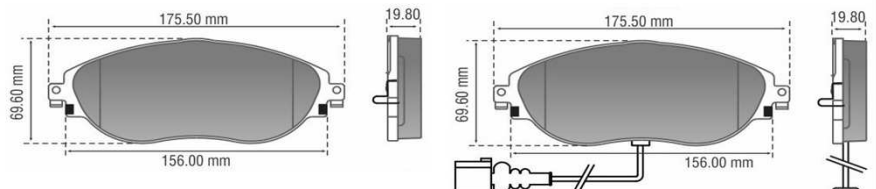

(1131) RD12511M

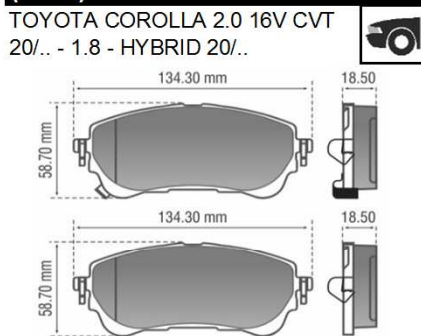

(1250) RD12512M

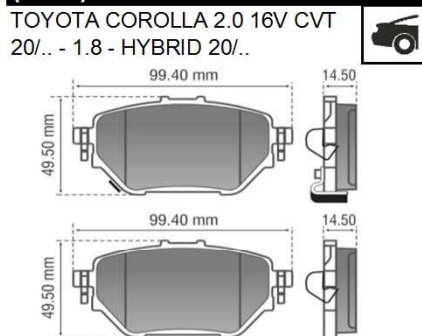

RD12513M

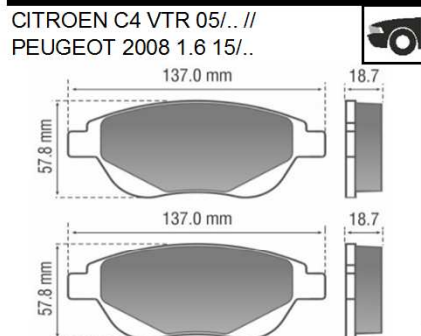

(0989) RD12522M

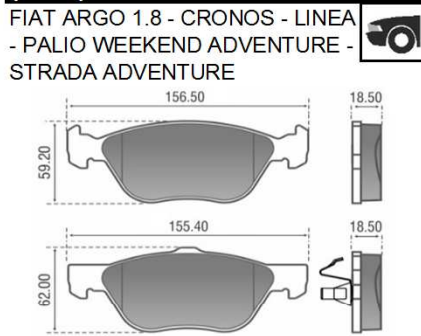

(1080) RD12523M

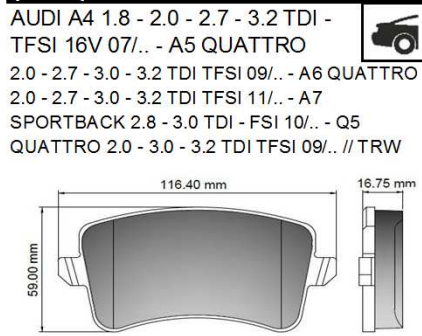

RD12524M

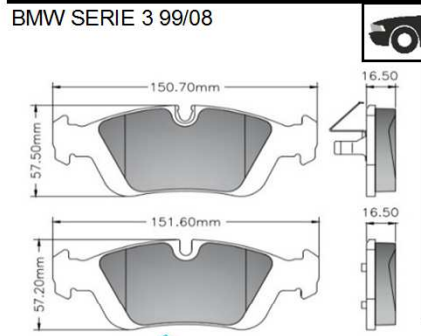

RD12526M

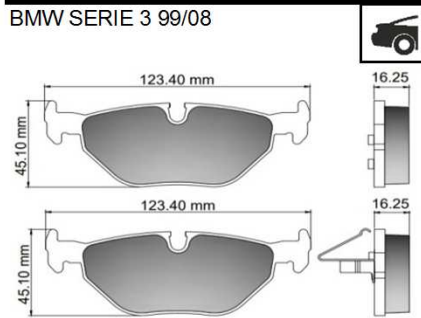

(1149) RD12527M

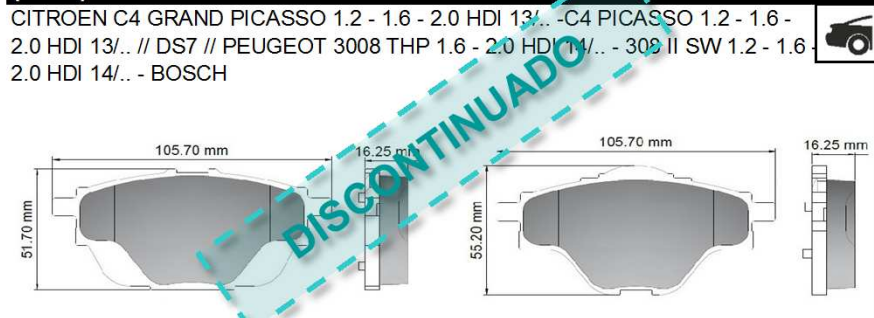

(1206) RD12530M

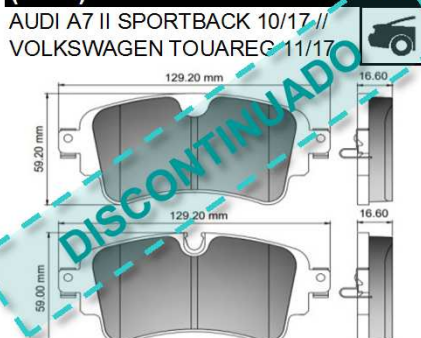

RD12531M

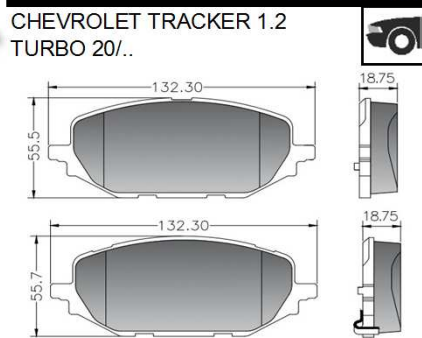

RD12532M

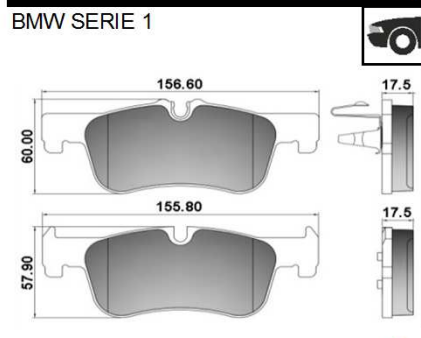

RD12533M

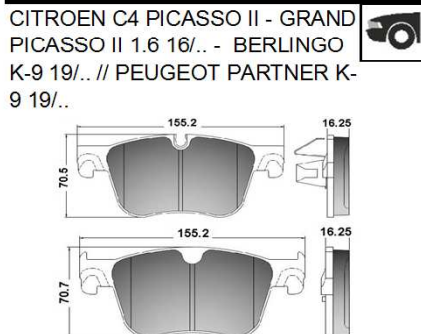

(1246) RD12535M

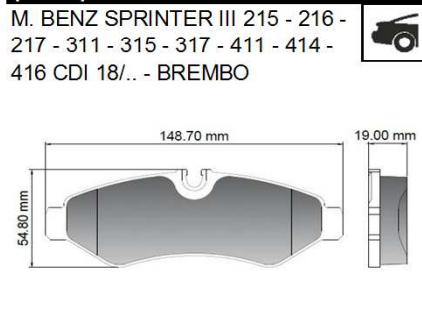

(1260) RD12536M

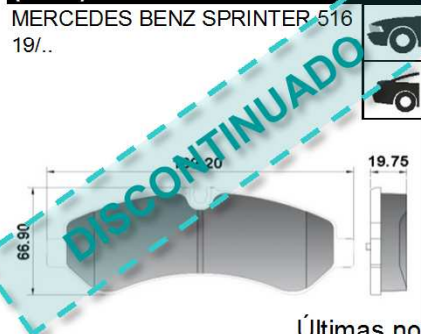



LISTA DE NOVEDADES

(0952) RD12537M

HONDA CITY - FIT - WR-V EX - EXL 1.5

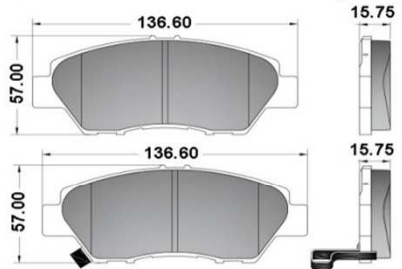

RD12544M

BMW SERIE 3 (E90 - E91 - E92) 06/12 - X1 (E84) 10/14

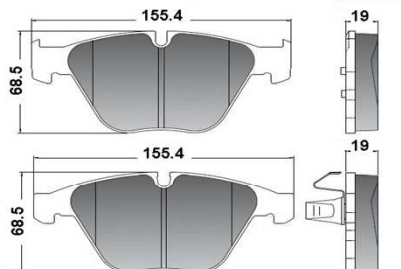

RD12548M

CHEVROLET EQUINOX 1.5 18/.. LLANTA 17"

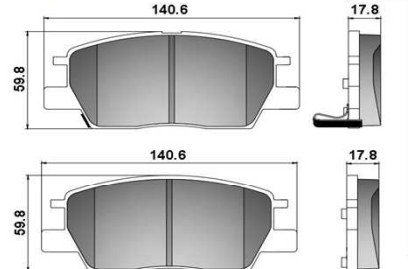

RD12549M

CHEVROLET EQUINOX 1.5 TURBO 18/..

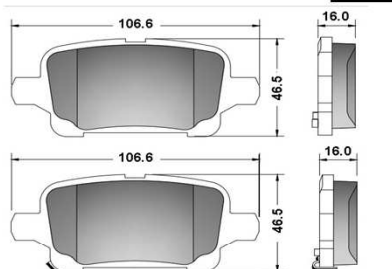

RD12550M

CITROEN C4 - C5 - DS4 // PEUGEOT 308 - 508 - RCZ

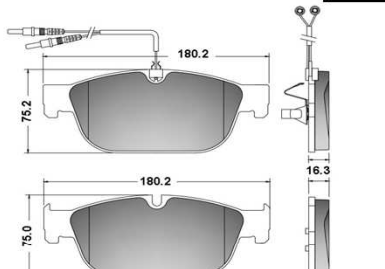

RD12552M

BMW X1 15/.. - BMW 2 ACTIVE // MINI CLUBMAN

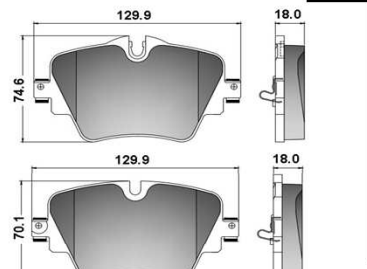

RD12553M

BMW X1 15/.. - BMW 2 ACTIVE // MINI CLUBMAN

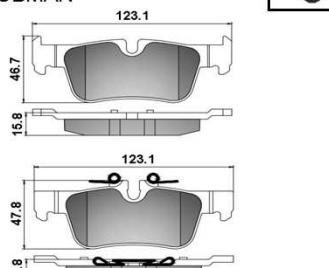

RD12554M

CITROEN C4 - C4 PICASSO - BERLINGO // PEUGEOT 5008 - PARTNER // DS4

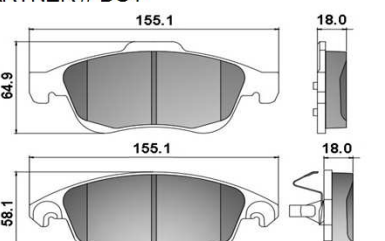

RD12555

CITROEN C4 // PEUGEOT 207 - 207SW - 307

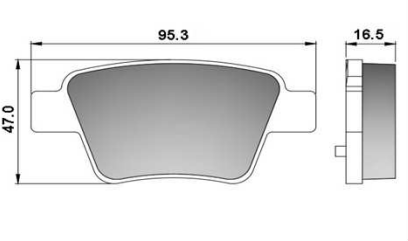

(0979) RD12959AM

A. ROMEO 156 2.0 00/02 // FIAT LINEA 1.4, 1.8 08/.. - BRAVO 11/..

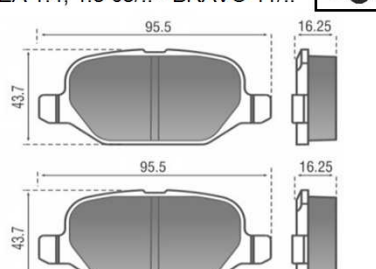

(0852) RD12902AM

M. BENZ ACCELO 915-C 16/.. - ATEGO I 1017 a 1023 - 712 a 717 - 812 a 823 - 917 a 923 98/..

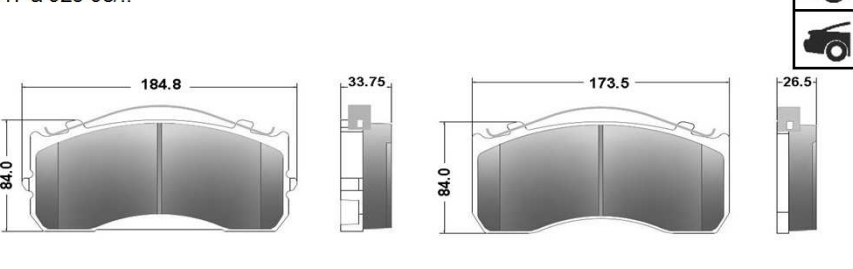

(1219) RD12972M

MB SPRINTER 3.5 - 3T. - 4.6T. - 5T. - VITO NVA. APLIC.

