



# LISTA DE NOVEDADES

## INCOPORACIONES AL:



CATALOGO GENERAL



CATALOGO CHAJA



CATALOGO BOMBAS Y CILINDROS



CATALOGO PASTILLAS DE FRENO



CATALOGO TREN DELANTERO



Av. Mitre 1293 - (1878) Quilmes, Bs. As. - Rep. Argentina - [WWW.ITALFREN.COM.AR](http://WWW.ITALFREN.COM.AR) - [info@italfren.com.ar](mailto:info@italfren.com.ar)

(011) 7504-4545 / 4618 (Telecentro) - (011) 5057-8417 Whatsapp

Fax s/cargo 0800-222-2047



# LISTA DE NOVEDADES



## CUBETAS PARA BOMBAS Y CILINDROS



# B

| Cód.   | Med. | Aplicación                       | Ilustración | Incorp. |
|--------|------|----------------------------------|-------------|---------|
| B70261 | 7/8" | CUBETA P/BOMBA - TIPO ORIGINAL - |             | JUL-24  |



## REPARACIONES DE FRENOS A DISCO



# C

| Cód.   | Med. | Aplicación  | Ilustración | Incorp. |
|--------|------|---|-------------|---------|
| C3033  | 80mm | REP. CALIPER DELANTERO DODGE RAM 2500   |             | JUN-23  |
| C3093  | 45mm | REP. CALIPER DEL. RENAULT MASTER - MB. SPRINTER - BOSCH   |             | OCT-22  |
| C3201  | 36mm | REP. CALIPER TRASERA TOYOTA COROLLA   |             | OCT-22  |
| C3202  | 38mm | REP. CALIPER TRASERO PEUGEOT 307/308 - CITROEN C4   |             | JUN-23  |
| C4612  | 38mm | REP. CALIPER TRASERA COMPLETA (GOMA+METAL) CITROEN C5 - FORD FOCUS - FOCUS C-MAX - KUGA - RENAULT LAGUNA - MEGANE - VOLVO S40 - V50 |             | OCT-22  |
| C10142 | 48mm | REP. CALIPER TRASERA VOLKSWAGEN AMAROK V6   |             | MAR-24  |
| C10144 | 48mm | REP. CALIPER TRASERA FORD TRANSIT   |             | MAR-24  |





# LISTA DE NOVEDADES



## JUEGOS DE PERNOS GUIA P/CALIPERS Y SUS PARTES

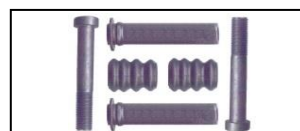

# D

| Código  | Aplicación  | Imagen | Sist.  | Ubic.      | Medida                        | Incorp |
|---------|---|--------|--------|------------|-------------------------------|--------|
| D7216S  | KIT PERNOS DESLIZ. C/FUELLES FORD EXPLORER - F-150 97/02 - RANGER - SUPERMEDIDA |        | BENDIX | -          | 70,3 x 10,5                   | ABR-24 |
| D7787   | KIT BUJES DE CALIPERS MERCEDES BENZ SPRINTER 411 - 414 19/..                    |        | BREMBO | DEL. TRAS. | BUJE 63 x 18<br>PERNO 12 x 84 | MAR-24 |
| D7864   | <b>NUEVA APLICACIÓN:</b> KIT PERNOS DE CALIPER FORD FIESTA KINETIC DESIGN       |        |        |            | 70 x 9,5                      | OCT-22 |
| D7871   | KIT DE PERNOS DESLIZ. C/ FUELLES PEUGEOT 206 - 306                              |        | BOSCH  | -          | 68,50x10                      | AG-22  |
| D7872   | KIT DE PERNOS DESLIZANTES C/FUELLES HYUNDAI TUCSON 12/.. - KIA SPORTAGE 12/..   |        | -      | -          | 72x9,85                       | AG-22  |
| D8081   | KIT PERNOS CHEVROLET AVEO   |        | -      | -          | 59x10                         | AG-22  |
| D8084   | KIT BUJES C/RECTIFICADO Y CROMO DURO IVECO 70C16 - 70HD                         |        | -      | -          | 90x22                         | AG-22  |
| D8084/K | KIT BUJES C/RECTIFICADO Y CROMO DURO + TORNILLOS IVECO 70C16 - 70HD             |        | -      | -          | 90x22<br>120x12               | AG-22  |





# LISTA DE NOVEDADES

| Código   | Aplicación   | Imagen | Sist.  | Ubic. | Medida               | Incorp |
|----------|--|--------|--------|-------|----------------------|--------|
| D8084/KF | KIT BUJES C/RECTIFICADO Y CROMO DURO + TORNILLOS C/FUELLES IVECO 70C16 - 70HD (KIT COMPLETO) |        | -      | -     | 90x22<br>120x12      | AG-22  |
| D8086    | KIT PERNOS Y FUELLES - COMPLETO- RENAULT MASTER II 12/..                                     |        | BREMBO |       | 80x18                | ABR-24 |
| D8092    | KIT VOLKSWAGEN AMAROK  |        | -      | TRAS  | 77 alt.<br>9,9 diam. | MAY-24 |



## REPARAC. DE SERVO NACIONAL - IMPORTADO



| Código  | Sist.                   | Imagen | Aplicación  | Incorp |
|---------|-------------------------|--------|---|--------|
| E1024D  | TRW<br>LUCAS<br>GIRLING |        | DIAFRAGMA PARA SERVO SIMPLE FORD COURIER - FIESTA - KA - DIAM. EXT. 240mm - AGUJ. INT. 55mm   | ABR-24 |
| E1030   | ATE                     |        | JGO. REP. SERVO RENAULT LOGAN - SANDERO   | ABR-23 |
| E1177   | ATE                     |        | JUEGO DE REPARACIONES P/SERVO DT CHEVROLET CRUZE  | AG-22  |
| E1177DA | ATE                     |        | DIAFRAGMA SUPERIOR CHEVROLET CRUZE (similar a diafragma VW Amarok pero más chico) - Ø EXT.: 224mm - Ø AGUJ.: 35mm - ENTRECENROS 100mm | -      |
| E1177DB | ATE                     |        | DIAFRAGMA INFERIOR CHEVROLET CRUZE (similar a diafragma VW Amarok pero más chico) - Ø EXT.: 241mm - Ø AGUJ.: 58mm - ENTRECENROS 100mm | -      |
| E1178   | AISIN                   |        | JUEGO REP. PARA SERVO SIMPLE TOYOTA COROLLA - E120 - FUNCARGO - VITZ  | AG-22  |







# LISTA DE NOVEDADES

| Código | Sist. | Imagen  | Aplicación   | Incorp |
|--------|-------|---|--|--------|
| E1178D | AISIN |    | DIAFRAGMA PARA SERVO SIMPLE TOYOTA COROLLA - E120 - FUNCARGO - VITZ - Ø EXT.: 241mm - Ø AGUJ.: 38mm  | -      |
| E1179  | TRW   |    | JUEGO REP. PARA SERVO SIMPLE CHEVROLET CRUZE - OTROS   | AG-22  |
| E1179D | TRW   |    | DIAFRAGMA PARA SERVO SIMPLE CHEVROLET CRUZE - OTROS (similar al E1155D, tetones grandes) - Ø EXT.: 270mm - Ø AGUJ.: 52mm - ENTRECENROS 105mm | -      |
| E1180  | ATE   |    | JUEGO REP. PARA SERVO VW PASSAT - TIGUAN   | OCT-23 |
| E1180D | ATE   |   | DIAFRAGMA PARA SERVO VW PASSAT - TIGUAN - Ø EXT.: 290mm  | OCT-23 |
| E1181  | KDAC  |  | JUEGO REP. SERVO CHEVROLET SPIN (CON TETONES) - Ø EXT.: 265mm  | ABR-24 |
| E1181D | KDAC  |  | DIAFRAGMA PARA SERVO CHEVROLET SPIN (CON TETONES) - Ø EXT.: 265mm  | OCT-23 |
| E5476  | ATE   |  | DIAFRAGMA RENAULT LOGAN - SANDERO - Ø EXT.: 236mm  | ABR-23 |



## DESPIECE Y REPARAC. SERVO TENSA

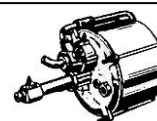

# F

| Cód.     | Imagen  | Descripción                                      | Incorp. |
|----------|---|--|---------|
| FT9629/1 |  | VALVULA RETENCION SERVO TENSA - ORIGINAL P/CURVO | MAY-24  |





# LISTA DE NOVEDADES



## PISTONES PARA CALIPERS

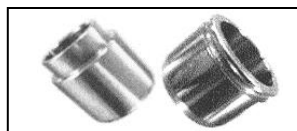

# G

| Cód.   | Ø  | Alt. | Descripción  | Sistema | Imagen | Incorp |
|--------|----|------|--|---------|--------|--------|
| G01036 | 36 | 49   | TOYOTA COROLLA 06/.. (TRASERO)   | -       |        | OCT-22 |
| G01039 | 54 | 51   | FIAT GRAND SIENA<br>FORD ECOSPORT  | -       |        | AG-22  |
| G01041 | 57 | 56   | A. ROMEO GIULIETTA - AUDI A4 - A5 - Q3 -<br>BMW SERIE 3 - XI - Z4 - CITROEN C4 - FIAT<br>DOBLO - 500 - FORD C-MAX - FOCUS - KUGA -<br>MONDEO - TRANSIT - HONDA ACCORD -<br>CIVIC - IVECO DAILY | -       |        | AG-22  |
| G01042 | 34 | 46   | HYUNDAI TUCSON (TRASERO)<br>KIA SPORTAGE (TRASERO)   | -       |        | AG-22  |
| G01043 | 48 | 54   | RENAULT MASTER II 12/.. (TRASERO)  | -       |        | OCT-22 |
| G01044 | 30 | 44   | HONDA CITY - FIT 10/.. (TRASERO)   |         |        | AG-23  |
| G01045 | 54 | 48   | HONDA CITY - FIT 10/.. (TRASERO)   | -       |        | OCT-22 |



## FLEXIBLES PARA FRENOS

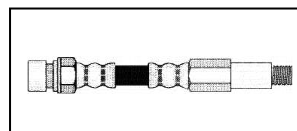















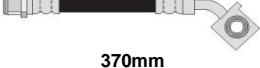

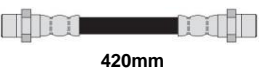

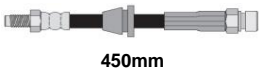

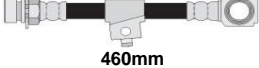



# H

| Código            | Imagen | Descripción | Incorp. | Código | Imagen | Descripción                                    | Incorp. |
|-------------------|--------|-------------|---------|--------|--------|--|---------|
| <b>ALFA ROMEO</b> |        |             |         |        |        |  |         |
|                   |        |             |         | H2235  |        | 33 88/92<br>145 - 156 94/..<br>155 TS 6V 92/.. | JUL-24  |
|                   |        |             |         |        | 185mm  | VER  | TRAS    |



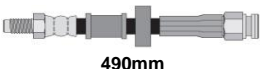

























# LISTA DE NOVEDADES

| Código           | Imagen   | Descripción   | Incorp. | Código | Imagen  | Descripción  | Incorp. |
|------------------|--|---|---------|--------|---|--|---------|
| <b>BMW</b>       |  |   |         |        |   |  |         |
| H7315            | <br>450mm   | SERIE 3 316, 318, 320, 323, 325, 318 TDS, 325 TDS<br>91/.. DEL                  | JUL-24  |        |   |  |         |
| <b>CHEVROLET</b> |  |   |         |        |   |  |         |
| H4007            | <br>344mm   | VERANEIO C10, C15<br>74/.. DEL  | JUL-24  | H4067  | <br>210mm   | LUMINA APV VAN 3.1, 3.4, 3.8<br>90/96 TRAS   | JUL-24  |
| H4087            | <br>345mm   | ASTRA 91/97<br>KADETT E 85/..<br>VER DEL  | JUL-24  | H4095  | <br>244mm   | KADETT (F/D 4RDAS), MONZA<br>88/.. TRAS  | JUL-24  |
| H4124            | <br>370mm   | CRUZE<br>17/.. DEL/DER  | MAY-24  | H4125  | <br>370mm   | CRUZE<br>17/.. DEL/IZQ   | MAY-24  |
| H4136            | <br>460mm   | ONIX PLUS LT<br>20/.. DEL/DER   | MAY-24  | H4137  | <br>460mm   | ONIX PLUS LT<br>20/.. DEL/IZQ.   | MAY-24  |
| H4138            | <br>420mm  | ONIX LT, LTZ<br>ONIX PLUS LT, L<br>20/.. TRAS                                   | MAY-24  | H4145  | <br>240mm  | AGILE 10/17<br>CLETA 10/15<br>VER TRAS   | MAY-24  |
| H4114/1          | <br>450mm | ONIX 13/.. - PRISMA -<br>SPIN 12/..<br>VER DEL.                                 | OCT-22  | H4121  | <br>375mm | TRACKER (FRENO A<br>TAMBOR)<br>13/.. TRAS  | OCT-22  |
| H82034           | <br>460mm | LUMINA APV VAN 3.1, 3.4<br>90/91 DEL/DER  | JUL-24  | H4181  | <br>250mm | ZAFIRA<br>99/.. TRAS   | JUL-24  |
| H82065           | <br>430mm | LUMINA APV VAN 3.1, 3.4<br>90/91 DEL/IZQ  | JUL-24  | H82337 | <br>320mm | LUMINA<br>91/94 TRAS   | JUL-24  |
| H86002           | <br>585mm | BLAZER 2WD (USA)<br>JIMMY, YUKON 2WD<br>73/78 DEL/DER                           | JUL-24  | H86304 | <br>380mm | BLAZER 2WD,4WD (USA)<br>74/91<br>JIMMY, YUKON 2WD, 4WD<br>74/91<br>IMPALA STATION WAGON<br>74/76<br>VER TRAS | JUL-24  |
| H86003           | <br>585mm | BLAZER 2WD (USA)<br>JIMMY, YUKON 2WD<br>73/78 DEL/IZQ                           | JUL-24  |        |   |  |         |
| <b>CITROEN</b>   |  |   |         |        |   |  |         |
| H8104            | <br>210mm | C3<br>04/.. TRAS  | JUL-24  | H8127  | <br>400mm | XANTIA<br>93/.. DEL  | JUL-24  |
| H8129            | <br>470mm | XSARA 1.4, 1.6 F/T, C/ABS<br>F/D 97/.. - ZX 1.6, 2.0, BREAK<br>91/..<br>VER DEL | JUL-24  | H8130  | <br>490mm | JUMPER (2 por rda.)<br>94/.. DEL   | JUL-24  |
|                  |  |   |         | H46039 | <br>265mm | XSARA 1.4, 1.6 C/ABS F/D<br>(D/DER) 97/.. - ZX BREAK<br>91/..<br>VER TRAS                                    | JUL-24  |



# LISTA DE NOVEDADES













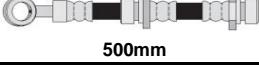

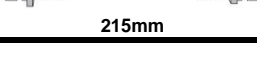



| Código             | Imagen  | Descripción  | Incorp. | Código   | Imagen   | Descripción  | Incorp. |
|--------------------|---|--|---------|----------|--|--|---------|
| <b>DAIHATSU</b>    |   |  |         |          |  |  |         |
| H17072             |    | A10 1.2 76/78 - A20<br>1.4 76/79 F/T y F/D   | JUL-24  | H17078   |    | A35, 45, 60, CHARMANT 1.3<br>y 1.6 (TRAS) 82/86 - A201.4,<br>CHARMANT 1.4 76/80<br>(EMBR.) | JUL-24  |
|                    |   | VER  |         |          |  | DEL  |         |
| H43867<br>EX H1391 |    | FEROZA, ROCKY  | JUL-24  |          |  |  |         |
|                    |   | 89/92  |         | DEL      |  |  |         |
| <b>DODGE</b>       |   |  |         |          |  |  |         |
| H8386              |    | RAM 1500, 2500 (ABS<br>atrás)  | JUL-24  | H87058   |    | RAM 1500, 2500 (ABS<br>atrás)  | JUL-24  |
|                    |   | 95/99  |         |          |  | D/IZQ  |         |
| H33972             |    | D100 - BOMBA<br>MAESTRA  | JUL-24  | H33972/1 |    | D100 - BBA. MAESTRA<br>C/MACHO FIJO 7/16"x20   | JUL-24  |
|                    |   |  |         |          |  |  |         |
| H41574             |    | D500, D600 59/60 - D200,<br>D250, D700, '60 - M300 69/76<br>- P200 '61 - P300, P350 69/78<br>- W100, W150, '59 - W300,<br>W350 61/71 | JUL-24  | H87310   |    | A100, D150 78/89 -<br>D100, D150, D200,<br>D250, D300, D350<br>82/89                       | JUL-24  |
|                    |   | VER  |         |          |  | DEL  |         |
| H87324             |  | D100, D150 78/89 - D100,<br>D150, D200, D250, D300,<br>D350 82/89  | JUL-24  |          |  |  |         |
|                    |   | VER  |         | TRAS     |  |  |         |
| <b>FIAT</b>        |   |  |         |          |  |  |         |
| H9138              |  | 500X   | OCT-22  | H9140    |  | 500X   | OCT-22  |
|                    |   | 14/..  |         |          |  | DEL.   |         |
| H2130              |  | ARGO 17/.. - CRONOS<br>18/.. - MOBI 17/..  | MAY-24  | H2137    |  | ARGO - CRONOS -<br>FASTBACK - PULSE  | MAY-24  |
|                    |   | VER  |         |          |  | DEL.   |         |
| H2039              |  | MOBI   | MAY-24  | H2114    |  | PUNTO  | OCT-22  |
|                    |   | 16/..  |         |          |  | TRAS   |         |
| H2141              |  | NVO. STRADA  | MAY-24  | H248484E |  | DUNA ELBA FIORINO<br>PREMIO UNO - H-H 10x1   | MAY-24  |
|                    |   | 21/..  |         |          |  | DEL.   |         |
| H2230              |  | TORO 07/19<br>DOBLO 07/..  | OCT-22  | H2231    |  | TORO 07/19<br>DOBLO 07/..  | OCT-22  |
|                    |   | VER  |         |          |  | DEL.   |         |
| <b>FORD</b>        |   |  |         |          |  |  |         |
| H3123              |  | F4000 (F/D)  | OCT-22  | H3124    |  | F4000 (F/D)  | OCT-22  |
|                    |   |  |         |          |  | TRAS/DER.  |         |
| H3192              |  | MONDEO III   | OCT-22  | H3184    |  | RANGER (DOBLE<br>CONEXIÓN)   | OCT-22  |
|                    |   | 00/07  |         |          |  | DEL.   |         |
| H3198              |  | TRANSIT  | MAY-24  | H3220    |  | F600 SERIE 6000<br>F700 SERIE 7000<br>F800 - F850 SERIE 8000                               | MAY-24  |
|                    |   | 11/..  |         |          |  | DEL.   |         |





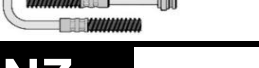











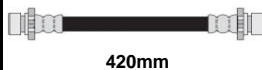

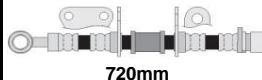
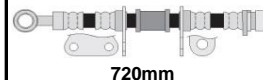
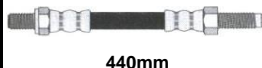
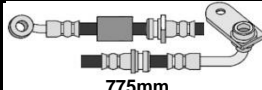
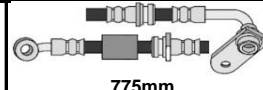

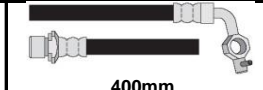
# LISTA DE NOVEDADES

| Código               | Imagen  | Descripción  | Incorp. | Código | Imagen   | Descripción   | Incorp. |
|----------------------|---|--|---------|--------|--|---|---------|
| <b>HYUNDAI</b>       |   |  |         |        |  |   |         |
| H4814                |    | H1<br>07/15 DEL/DER  | MAY-24  | H4815  |    | H1<br>07/15 DEL/IZQ   | MAY-24  |
| H4623                |    | MANGUERA DEPRESOR<br>H100 94/16 - GALLOPER<br>2.5 DIESEL 91/03 - K2500 | MAY-24  | H4569  |    | ELANTRA 01/06<br>TIBURON 03/08  | MAY-24  |
| H4579                |    | ELANTRA 97/06 F/T<br>ACCENT 95/99 F/T<br>VER TRAS                      | MAY-24  | H4811  |    | HB20<br>11/17 TRAS  | MAY-24  |
| H4819                |    | CRETA<br>15/20 TRAS  | MAY-24  |        |  |   |         |
| <b>IVECO</b>         |   |  |         |        |  |   |         |
| H2119                |    | DAILY<br>08/.. DEL   | MAY-24  | H2120  |    | DAILY II<br>90/99 TRAS  | MAY-24  |
| <b>JEEP</b>          |   |  |         |        |  |   |         |
| H9128                |  | GRAND CHEROKEE<br>T/D 99/04  | MAY-24  |        |  |   |         |
| H9138                |  | RENEGADE<br>16/.. DEL.   | OCT-22  | H9140  |  | RENEGADE<br>16/.. TRAS.   | OCT-22  |
| <b>KIA</b>           |   |  |         |        |  |   |         |
| H8310                |  | BESTA GS 2.7L<br>00/06 DEL   | MAY-24  | H4622  |  | BESTA 2.2L 92/03 -<br>K2500 2.5L 01/04 - K2700<br>2.7L 93/05<br>VER DEL | MAY-24  |
| H4816                |  | SORENTO II<br>09/15 DEL/DER  | MAY-24  | H4817  |  | SORENTO II<br>09/15 DEL/IZQ   | MAY-24  |
| H4624                |  | SPORTAGE<br>95/02 DEL/DER  | MAY-24  | H4626  |  | SPORTAGE<br>95/02 DEL/IZQ   | MAY-24  |
| <b>MERCEDES BENZ</b> |   |  |         |        |  |   |         |
| H5054                |  | SPRINTER MACHO<br>LARGO 38mm<br>08/.. DEL/TRAS                         | MAY-24  | H5056  |  | SPRINTER<br>95/06 TRAS  | MAY-24  |
| <b>NISSAN</b>        |   |  |         |        |  |   |         |
| H5846                |  | FRONTIER<br>18/.. DEL.   | OCT-22  |        |  |   |         |
| <b>RASTROJERO</b>    |   |  |         |        |  |   |         |
| H89999E              |  | ULTIMA SERIE<br>INDENOR - PUNTERA<br>HEMBRA<br>D/T                     | MAY-24  |        |  |   |         |



# LISTA DE NOVEDADES

| Código                    | Imagen   | Descripción  | Incorp. | Código  | Imagen  | Descripción  | Incorp. |
|---------------------------|--|--|---------|---------|---|--|---------|
| <b>RENAULT</b>            |  |  |         |         |   |  |         |
| H5850                     | <br>430mm   | ALASKAN<br>17/.. DEL/DER   | MAY-24  | H5851   | <br>430mm   | ALASKAN<br>17/.. DEL/IZQ.  | MAY-24  |
| H5852                     | <br>420mm   | ALASKAN<br>17/.. TRAS  | MAY-24  | H8273   | <br>305mm   | LOGAN II<br>TRAS.  | OCT-22  |
| <b>ROVER - LAND ROVER</b> |  |  |         |         |   |  |         |
| H6098                     | <br>720mm   | ROVER 618 I/SI - 620 SdI -<br>620 Si - 620 Ti VITESSE -<br>623 Si<br>93/99 DEL/DER | MAY-24  | H6099   | <br>720mm   | ROVER 618 I/SI - 620 SdI -<br>620 Si - 620 Ti VITESSE -<br>623 Si<br>93/99 DEL/IZQ                         | MAY-24  |
| H6080                     | <br>440mm   | LAND ROVER SANTANA<br>D/T  |         |         |   |  |         |
| <b>SUZUKI</b>             |  |  |         |         |   |  |         |
| H7852                     | <br>775mm   | VITARA - GRAND<br>VITARA<br>98/15 DEL/DER  | MAY-24  | H7854   | <br>775mm   | VITARA - GRAND<br>VITARA<br>98/15 DEL/IZQ.   | MAY-24  |
| H7826                     | <br>300mm | SAMURAI 1.3 - 1.9<br>85/04 DEL.  | OCT-22  |         |   |  |         |
| <b>TOYOTA</b>             |  |  |         |         |   |  |         |
| H17118                    | <br>400mm | HIACE III<br>89/95 DEL/DER   | MAY-24  | H17119  | <br>400mm | HIACE III<br>89/95 DEL/IZQ.  | MAY-24  |
|                           |  |  |         | H17087  | <br>420mm | STOUT 2.0 RK110 (Doble<br>Cab & 1,5 Ton) 84/86 -<br>STOUT 2.2 YK110 (Doble<br>Cab & 1,5 Ton) 87/..<br>TRAS | MAY-24  |
| <b>VOLKSWAGEN</b>         |  |  |         |         |   |  |         |
| H7094                     | <br>700mm | AMAROK V6 - AMAROK<br>3.0 TDI, 3.0 TDI 4<br>MOTION (OJAL 10mm)<br>16/22 DEL.       | MAY-24  | H7079/1 | <br>260mm | BORA (OJAL 10mm)<br>TRAS.  | MAY-24  |
| H7080                     | <br>650mm | T-CROSS<br>17/.. DEL.  | OCT-22  | H7088   | <br>200mm | T-CROSS<br>17/.. TRAS.   | OCT-22  |
| H7020                     | <br>415mm | VARIANT II<br>77/.. DEL.   | MAY-24  | H7084   | <br>430mm | TOUAREG<br>03/18 TRAS.   | MAY-24  |



# LISTA DE NOVEDADES



## CABLES DE FRENO, EMBRAGUE Y SELECTORA

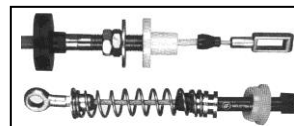

| Código | Aplicación  | Largo | Nº OEM                              | Incorp |
|--------|---|-------|-------------------------------------|--------|
| i268   | CAMBIO DE VELOCIDADES AUTOMATICO FORD TAUNUS  | 1300  | 78BR7A482A                          | AG-22  |
| i661   | EMBRAGUE FIAT 132 ARGENTA todos - Diesel Bosch 81/..  | 1130  | 4380878                             | ABR-24 |
| i790   | EMBRAGUE GM/CHEVROLET/OPEL SUPREMA 2.0 - 2.2 MPFI 4 CIL. 92/98 - SENATOR 88/93  | 1226  | 90335385 - 669159                   | AG-22  |
| i902   | EMBRAGUE MANGO HEX. C/2 TUERCAS P-504   |       |                                     | ENE-23 |
| i3015  | EMBRAGUE FIAT MAREA MOTOR 1.9 TD 95/02  | 1510  | 46448106 - 46797595                 | ENE-24 |
| i3565  | EMBRAGUE VW 1600 / SAFARI REFORZADO / KARMAN GHIA Ghia 72/..  | 2290  | 111721335C                          | JUN-22 |
| i3632  | FRENO TRAS/D-I VW 1300 - 1500 - 1600 81/86  | 1770  | 1136097211 - 113609721L             | JUN-22 |
| i3676  | EMBRAGUE VW BRAZILIA - REFORZADO  | 2345  | adaptación 31 1721335A - 3117213351 | JUN-22 |
| i3694  | EMBRAGUE RENAULT 5 MIRAGE   |       |                                     | ENE-23 |
| i3980  | EMBRAGUE CON 2 CONTRAPESOS RENAULT 21 - NEVADA - RX - TXE - MEDALLON - ETOILE 87/..   | 1230  | 7700763190                          | AG-22  |
| i4016  | CAMBIO DE VELOCIDADES M. BENZ OMNIBUS 1725  | 10250 | A3822600351                         | AG-22  |
| i4019  | CAMBIO DE VELOCIDADES M. BENZ OMNIBUS O500 RS   | 11000 | A6292682891                         | AG-22  |
| i4055  | EMBRAGUE DAEWOO MATIZ 1.0 4V 05/..  | 835   | 96590793 - 25187023                 | AG-22  |
| i4056  | EMBRAGUE NISSAN TSURU III 1.6L 03/16  | 800   | 30770F4203                          | AG-22  |
| i4488  | EMBRAGUE GM/CHEVROLET/OPEL PICK-UP A10 - A20 - C10 - C20 85/88  | 730   | 94647409                            | AG-22  |
| i4489  | EMBRAGUE GM/CHEVROLET/OPEL CAMIÓN D40 85/88   | 725   | 94647410                            | AG-22  |
| i4491  | FRENO TRASERO GM/CHEVROLET/OPEL A10 - A20 - C10 - C20 - D10 - D20 85/88   | 1240  | 94637224                            | AG-22  |
| i4495  | FRENO DELANTERO FORD F4000 MOTOR MWM ASPIRADO 92/98   | 2185  | T72609701                           | AG-22  |
| i4539  | EMBRAGUE GM/CHEVROLET/OPEL CHEVETTE 74/76   | 1190  | 9302835                             | AG-22  |
| i4540  | FRENO DELANTERO GM/CHEVROLET/OPEL A40 - C40 - D40 85/92   | 1490  | 94629727                            | AG-22  |
| i4544  | EMBRAGUE GM/CHEVROLET/OPEL PICK-UP A10 - C10 - D10 MOTOR 4 CILINDROS 79/84 - A14C y C14C 85/89                                    | 800   | 94602860                            | AG-22  |
| i4578  | FRENO TRASERO DERECHO/IZQUIERDO A CAMPANA VW POLO HATCH-SEDAN (BRASIL) 02/15  | 1660  | 6Q0609721K - 6Q0609721F             | AG-22  |
| i4635  | CAMBIO DE VELOC. INSERCIÓN FIAT NUEVO PALIO (326) 1.4 MPI FIRE 8V (CAJA C514) ATTRACTIVE 17/..                                    | 1100  | 55261463                            | AG-22  |
| i4636  | CAMBIO DE VELOC. SELECCIÓN FIAT NUEVO PALIO (326) 1.4 MPI FIRE 8V (CAJA C514) ATTRACTIVE 17/..                                    | 1185  | 55261464                            | AG-22  |
| i4654  | CAMBIO DE VELOCIDADES CITROEN NUEVA JUMPER 05/17 - FIAT NUEVA DUCATO 05/18 - PEUGEOT NUEVA BOXER 05/17 - 2 CABLES UNIDOS CON GOMA | 1038  | 71729169 - 2444V9 - 2444EC          | AG-22  |
| i4660  | FRENO DELANTERO A CAMPANA CHEVROLET ONIX - PRISMA 13/..   | 190   | 52026809                            | AG-22  |





# LISTA DE NOVEDADES

| Código | Aplicación   | Largo | Nº OEM                 | Incorp |
|--------|--|-------|------------------------|--------|
| i4661  | FRENO DEL. A CAMPANA CHEVROLET SPIN 12/..  | 230   | 52046580 - 52034393    | AG-22  |
| i4663  | CAMBIO DE VELOCIDADES INSERCIÓN FIAT UNO II 1.4 MPI FIRE 10/.. -RÓTULA GRANDE- (EXT. PLÁSTICOS)  | 1095  | 55222272 - 68198829AA  | AG-22  |
| i4664  | CAMBIO DE VELOCIDADES SELECCIÓN FIAT UNO II 1.4 MPI FIRE 10/.. -RÓTULA CHICA- (EXT. PLÁSTICOS)   | 1000  | 55222273 - 68198830AA  | AG-22  |
| i4670  | CAMBIO DE VELOCIDADES TOYOTA YARIS 1.5 VVTI 16V 6 VELOC. 18/.. -2 CABLES UNIDOS POR GOMA-  | 1080  | 338200D760             | AG-22  |
| i4671  | CAMBIO DE VELOC. CHEVROLET ONIX - PRISMA CAJA DE 5 VELOC. 20/.. -2 CABLES UNIDOS POR GOMA-   | 1085  | 24590069 - 24590218    | AG-22  |
| i4672  | CAMBIO DE VELOCIDADES FORD FIESTA - COURIER 1.6L 16V 5 VELOC. 15/.. -2 CABLES CON GOMA UNIÓN-  | 1700  | D2BZ7E395C             | AG-22  |
| i4689  | CAMBIO DE VELOCIDADES VW NIVUS 1.0 T AT6 20/..   | 1400  | 2Q0713266M             | AG-22  |
| i4695  | CAMBIO VELOC. FIAT DUCATO - TALENTO 2.3 16V TURBO DIESEL MULTIJET -2 CABLES UNIDOS CON GOMA- 19/..   | 1050  | 55284171 - K68403724AA | AG-22  |
| i4712  | BIELETA PEDAL DE EMBRAGUE PEUGEOT 206 - 207 - HOGGAR   | -     | 212830                 | OCT-22 |
| i4713  | BIELETA PEDAL DE EMBRAGUE CITROEN BERLINGO - PEUGEOT PARTNER   | -     | 212831                 | OCT-22 |
| i4716  | FRENO TRASERO EXTENSION A CAMPANA CHEVR. ONIX y PRISMA 13/.. - COBALT y SONIC 12/..  | 230   | 95492584 - 95231322    | OCT-22 |
| i4717  | FRENO TRASERO EXTENSION A CAMPANA CHEVR. SPIN 12/.. - TRACKER y TRAX 13/..   | 235   | 95492583               | OCT-22 |
| i4719  | FRENO TRASERO A DISCO FORD FOCUS III 13/.. - 2 CABLES CON CHAPA UNION  | 1970  | AV612A603BL            | OCT-22 |
| i4721  | CAMBIO DE VELOCIDADES (CAMBIO AT6) CAJA AUTOMATICA - CITROEN C4 CACTUS 1.2 T PURETECH - 1.6 16V 17/... - C-ELYSEE 1.6 16V 17/20 - DS3 1.2 T PURETECH 17/... - PEUGEOT 301 1.6 16V 17/18 - PEUGEOT 208 1.6 16V EC5 12/... - PEUGEOT2008 1.6 16V EC5 16/.. | 1320  | 9814628080             | AG-22  |
| i4729  | CAMBIO VELOC. AUTOMÁT. FORD RANGER 12/..   | 1255  | AB397E395AF            | ENE-24 |
| i4730  | FRENO TRAS. A CAMPANA (SIN ABS) -2 CABLES CON CHAPA UNIÓN- FORD FOCUS II 08/13   | 2980  | 1707756 - 3M512A603EC  | MAR-23 |
| i4731  | FRENO DE MANO TRASERO A DISCO FORD FOCUS II  | 3730  | 1707757 - 3M512A603FC  | ENE-24 |
| i4745  | FRENO TRASERO DERECHO (SIN CHAPAS SOPORTE) NISSAN FRONTIER MWM 2.8 DTI 03/08   | 2270  | 365306S302             | AG-22  |
| i4746  | FRENO TRASERO IZQUIERDO NISSAN FRONTIER MWM 2.8 DTI 03/08  | 1095  | 365316S302             | AG-22  |
| i4749  | FRENO DELANTERO NISSAN FRONTIER MWM 2.8 DTI 03/08  | 2215  | 364028Z311             | ENE-24 |
| i4750  | FRENO TRASERO DERECHO NISSAN FRONTIER 2.3 DCI 16/18  | 2175  | 365304KH0B             | ENE-24 |
| i4751  | FRENO TRASERO IZQUIERDO NISSAN FRONTIER 2.3 DCI 16/18  | 2440  | 365314KH0B             | ENE-24 |
| i4752  | BIELETA PASAJE DE CAMBIOS PEUGEOT 207 - HOGGAR (CAJA MA) CHASIS 1148077/..   | 80    | 2454G8                 | ENE-24 |
| i4753  | BIELETA PASAJE DE CAMBIOS CITROEN XSARA - XSARA PICASSO  | 90    | 245286                 | ENE-24 |
| i4754  | BIELETA SELECCIÓN DE CAMBIOS CITROEN BERLINGO - PEUGEOT PARTNER - (CAJA BE4R)  | 115   | 2454F5                 | ENE-24 |







# LISTA DE NOVEDADES

| Código | Aplicación   | Largo | Nº OEM                         | Incorp |
|--------|--|-------|--------------------------------|--------|
| i4755  | BIELETA SELECCIÓN DE CAMBIOS PEUGEOT 206 - 207 - HOGGAR (CAJA BE4R)  | 120   | 2454G4                         | ENE-24 |
| i4756  | BIELETA SELECCIÓN DE CAMBIOS PEUGEOT 206- 207 - HOGGAR (CAJA MA)   | 160   | 2454G5                         | ENE-24 |
| i4757  | BIELETA PASAJE DE CAMBIOS CITROEN BERLINGO - PEUGEOT PARTNER - 206 - 207 - HOGGAR - (CAJA BE4R)  | 280   | 245281                         | ENE-24 |
| i4758  | EMBRAGUE REGULACION AUTOMATICA C/CONTRAPESO CITROEN BERLINGO 1.4 N (75 CV) - 1.6 16v (110 CV) - 1.6 HDI (90 CV) 10/16 - PEUGEOT PARTNER 1.4 N (75 CV) - 1.6 16v (110 CV) - 1.6 HDI (90 CV) 10/16 | 880   | 9825669080                     | AG-22  |
| i4759  | EMBRAGUE REGULACION MANUAL SIN CONTRAPESO CITROEN BERLINGO 1.4 N (75 CV) - 1.6 16v (110 CV) - 1.6 HDI (90 CV) 10/16 - PEUGEOT PARTNER 1.4 N (75 CV) - 1.6 16v (110 CV) - 1.6 HDI (90 CV) 10/16   | 940   | ADAPT. 9825669080 - 9837204380 | ENE-23 |
| i4766  | BIELETA PEDAL DE EMBRAGUE CITROEN BERLINGO - PEUGEOT 306 - PARTNER   | -     | 212822                         | ENE-23 |
| i4768  | FRENO TRAS/DER. A CAMPANA FIAT PULSE 1.3 DRIVE - 1.0T IMPETUS 22/..  | 1620  | 52156077                       | ENE-23 |
| i4769  | FRENO TRAS/IZQ. A CAMPANA FIAT PULSE 1.3 DRIVE - 1.0T IMPETUS 22/..  | 1650  | 52156078                       | ENE-23 |
| i4770  | FRENO TRAS/DER-IZQ. A DISCO VW VENTO 11/18   | 1625  | 5C0609721BC                    | ENE-23 |
| i4771  | FRENO DEL. A CAMPANA CHEVROLET SONIC 12/.. - COBALT 13/..  | 185   | 95229769 - 95937512            | ENE-23 |
| i4772  | FRENO DEL. TOYOTA COROLLA 08/14  | 320   | 4641002160 - 4641002170        | ENE-23 |
| i4776  | CAMBIO VELOCIDADES FIAT PULSE IMPETUS 1.0 - 1.3 DRIVE 1.3  | 1215  | 52150088                       | ENE-24 |
| i4777  | FRENO DELANTERO NISSAN FRONTIER 2.3 DCI 18/.. - RENAULT ALASKAN 2.3 DCI 20/..  | 555   | 364024KD0B                     | ENE-24 |
| i4778  | FRENO TRASERO DERECHO NISSAN FRONTIER 2.3 DCI 18/.. - RENAULT ALASKAN 2.3 DCI 20/..  | 2180  | 365305JL0A                     | ENE-24 |
| i4779  | FRENO TRASERO IZQUIERDO NISSAN FRONTIER 2.3 DCI 18/.. - RENAULT ALASKAN 2.3 DCI 20/..  | 2490  | 365315JL0A                     | ENE-24 |
| i4781  | FRENO TRASERO DERECHO NISSAN VERSA MOTOR 1.6 (107 CV) 13/20  | 1835  | 365303BA0A                     | ENE-24 |
| i4782  | FRENO TRASERO IZQUIERDO NISSAN VERSA MOTOR 1.6 (107 CV) 13/20  | 1825  | 365313BA0A                     | ENE-24 |
| i4785  | FRENO TRASERO DER/IZQ A CAMPANA 14/.. RENAULT LOGAN - SANDERO  | 1730  | 365306778R                     | MAY-23 |



## DEPOSITOS PARA LIQUIDO DE FRENOS



| Código | Imagen | Descripción                                 | Incorp. |
|--------|--------|---|---------|
| K4032  |        | DEP. LIQUIDO FRENO SIN TAPA CHEVROLET CORSA | ABR-24  |

| Código | Imagen | Descripción | Incorp. |
|--------|--------|-------------|---------|
|        |        |             |         |





# LISTA DE NOVEDADES



## CAÑOS DE COBRE Y CONEX. DE BRONCE



# M

| Cód.   | Med. | Aplicación                                   | Ilustración | Incorp. |
|--------|------|--|-------------|---------|
| M10107 | -    | DERIVADOR FORD RANGER 10x1 CON CONO (CHAPA)  |             | MAY-24  |
| M10108 | -    | DERIVADOR FORD RANGER 10x1 CON CONO (BLOQUE) |             | MAY-24  |



## DISCOS Y CAMPANAS



# N

| DISCOS DE FRENO      |   |       |        |        |         |         |         |         |              |   |         |
|----------------------|---|-------|--------|--------|---------|---------|---------|---------|--------------|---|---------|
| Cód.                 | Aplicación  | Año   | D<br>T | S<br>V | A<br>mm | B<br>mm | C<br>mm | D<br>mm | D Min.<br>mm | E | Incorp. |
| <b>FORD</b>          |   |       |        |        |         |         |         |         |              |   |         |
| N4159                | FORD MAVERICK 2.0 16V TURBO 21/.. - MAVERICK 2.5 HYBRID 22/..                                       |       | T      | S      | 302,0   | 41,0    | 63,5    | 11,0    | 9,0          | 5 | JUN-24  |
| N4160                | FORD MAVERICK 2.0 16V TURBO 21/.. - MAVERICK 2.5 HYBRID 22/..                                       |       | D      | V      | 325,0   | 50,5    | 63,5    | 27,0    | 25,0         | 5 | JUN-24  |
| N7340                | FORD S-MAX 2.0 GDTI / ECOBOOST AT   | 17/.. | T      | S      | 316,0   | 50,9    | 63,6    | 11,0    | 9,5          | 5 | JUN-24  |
| <b>MERCEDES BENZ</b> |   |       |        |        |         |         |         |         |              |   |         |
| N0217                | MB A220 - B220 18/.. - MB A200 - CLA220 - GLB180 - GLB200 19/.. - MB CLA250 - GLA180 - GLA200 20/.. |       | D      | V      | 318,0   | 51,0    | 67,0    | 30,0    | 27,4         | 5 | JUN-24  |
| N0218                | MB CLASE A - CLASE B 18/.. MB CLA - GLB 19/.. - MB GLA 20/.. - MB EQA - EQB 21/..                   |       | T      | S      | 320,0   | 44,0    | 67,0    | 12,0    | 10,3         | 5 | JUN-24  |
| N0219                | MB CLASE A - CLASE B 18/.. - MB CLA - GLB 19/.. - MB GLA 20/..                                      |       | T      | S      | 295,0   | 44,0    | 67,0    | 12,0    | 10,3         | 5 | JUN-24  |
| N0130                | MB GLE 450 4MATIC   | 20/.. | D      | V      | 375,0   | 60,0    | 37,0    | 36,0    | 33,4         | 5 | JUN-24  |
| N0131                | MB GLE 450 4MATIC - GLE 53 AMG 4MATIC 20/.. - MB GLE 63 AMG S 4MATIC 21/..                          |       | T      | V      | 345,0   | 54,0    | 67,0    | 22,0    | 19,4         | 5 | JUN-24  |
| N0126                | MB GLE 450 4MATIC (PERFORADO)   | 20/.. | D      | V      | 375,0   | 59,5    | 67,0    | 36,0    | 34,0         | 5 | JUN-24  |
| N0129                | MB GLE 53 AMG 4MATIC - GLE 63 AMG 4MATIC (PERFORADO)  | 19/.. | D      | V      | 400,0   | 60,0    | 67,0    | 38,0    | 36,0         | 5 | JUN-24  |





# LISTA DE NOVEDADES

## DISCOS DE FRENO

| Cód. | Aplicación | Año | D<br>T | S<br>V | A<br>mm | B<br>mm | C<br>mm | D<br>mm | D Min.<br>mm | E | Incorp. |
|------|------------|-----|--------|--------|---------|---------|---------|---------|--------------|---|---------|
|------|------------|-----|--------|--------|---------|---------|---------|---------|--------------|---|---------|

## PORSCHE

|       |  |  |   |   |       |      |      |      |      |   |        |
|-------|--|--|---|---|-------|------|------|------|------|---|--------|
| N3334 | PORSCHE 718 BOXSTER<br>PERFORADO 06/17 - CAYMAN<br>PERFORADO 06/13 |  | T | V | 299,0 | 67,0 | 98,0 | 20,0 | 18,0 | 5 | JUN-24 |
|-------|--|--|---|---|-------|------|------|------|------|---|--------|

## SUBARU

|       |   |       |   |   |       |      |      |      |      |   |        |
|-------|---|-------|---|---|-------|------|------|------|------|---|--------|
| N6772 | SUBARU FORESTER 2.0 AWD CVT<br>XS - 2.5 AWD CVT | 18/.. | T | V | 285,0 | 46,5 | 58,0 | 17,0 | 15,0 | 5 | JUN-24 |
|-------|---|-------|---|---|-------|------|------|------|------|---|--------|

## TOYOTA

|       |   |       |   |   |       |      |       |      |      |     |        |
|-------|---|-------|---|---|-------|------|-------|------|------|-----|--------|
| N4118 | TOYOTA HILUX 2.8TDI AT - SW4<br>2.8TDI AT | 20/.. | D | V | 319,0 | 67,5 | 108,0 | 38,0 | 25,0 | 6+2 | ABR-24 |
|-------|---|-------|---|---|-------|------|-------|------|------|-----|--------|

## VOLKSWAGEN

|       |  |  |   |   |       |      |      |      |     |   |        |
|-------|--|--|---|---|-------|------|------|------|-----|---|--------|
| N5647 | VW VENTO 250 TSI 18/20 - TAOS<br>250 TSI 21/.. |  | T | S | 272,0 | 58,0 | 65,0 | 10,0 | 9,0 | 9 | JUN-24 |
|-------|--|--|---|---|-------|------|------|------|-----|---|--------|



# LISTA DE NOVEDADES



## CHAJA



# P

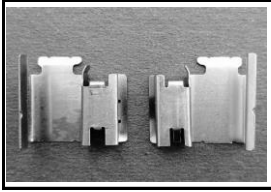

P1584

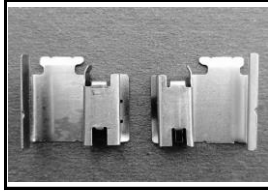

P1585



P1608



P1609



P1610



P1611



P1625



P1626

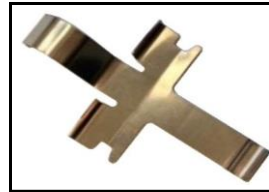

P1630



P1633



P2228A

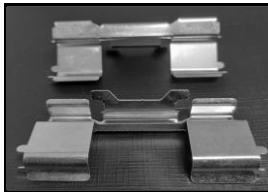

P2230A



P2233A



P2284A

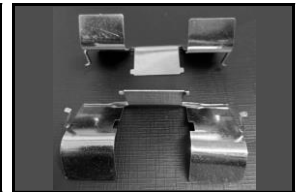

P2285A



P2520T



P2521T



P2522T



P2523T

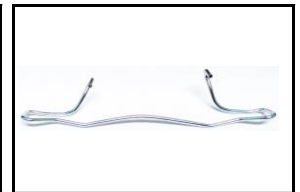

P2650

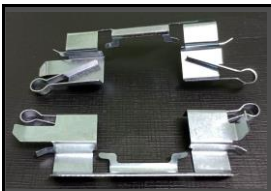

P7203



P9107



P9108



P9109



P9110



P9111



P9112



P22230



P22598

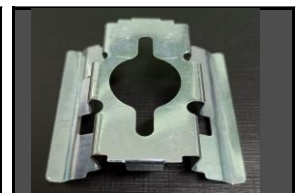

P42337

| Código | Marca              | Aplicación  | Incorp |
|--------|--------------------|---|--------|
| P1584  | CITR. - PEUG. - VW | ANTIRRUIDO DER/IZQ.- CITR. C4 VTS - C4 // PEUG. P307 // VW AMAROK - BOSCH NVA. APLICACIÓN   | SEP-23 |
| P1585  | CITR. - PEUG. - VW | ANTIRRUIDO DER/IZQ.- CITR. C4 VTS - C4 // PEUG. P307 // VW AMAROK - BOSCH - NVA. APLICACIÓN | SEP-23 |
| P1608  | TOYOTA             | JGO. LEVA IZQUIERDA TOYOTA HILUX 05/..  | FEB-23 |





# LISTA DE NOVEDADES

| Código | Marca                             | Aplicación   | Incorp |
|--------|-----------------------------------|--|--------|
| P1609  | TOYOTA                            | JGO. LEVA DERECHA TOYOTA HILUX 05/..   | FEB-23 |
| P1610  | IVECO                             | JUEGO LEVA IVECO (TODOS)   | MAR-23 |
| P1611  | CITR. - FIAT - PEUG.              | JGO. LEVA CITROEN JUMPER - FIAT DUCATO - PEUGEOT BOXER 01/17                           | SEP-23 |
| P1625  | CHEVROLET                         | REGISTRO IZQUIERDO CHEVROLET ASTRA - CORSA II - MERIVA                                 | FEB-23 |
| P1626  | CHEVROLET                         | REGISTRO DERECHO CHEVROLET ASTRA - CORSA II - MERIVA                                   | FEB-23 |
| P1630  | TOYOTA                            | ANTIRRUIDO DE CALIPER DEL. DER/IZQ. TOYOTA HILUX - ACERO                               | MAY-24 |
| P1633  | FORD                              | PERNO PARA GATILLO FORD RANGER   | SEP-23 |
| P2228A | CHEVROLET                         | KIT ANTIRRUIDO CHEVROLET S10 4x2 - 4x4 12/16   | MAY-24 |
| P2230A | IVECO                             | KIT ANTIRRUIDO PAST. IVECO 70C16, 70C17, 35S14 ECONOLINE CD                            | MAY-24 |
| P2233A | HYUNDAI                           | KIT ANTIRRUIDO PAST. HYUNDAI HR DEL.   | MAY-24 |
| P2284A | KIA                               | KIT ANTIRRUIDO CALIPER KIA BONGO, K2700, K2500 ../12, K2400 ../00                      | MAY-24 |
| P2285A | FIAT                              | KIT ANTIRRUIDO CALIPER FIAT DUCATO 16" C/ABS   | MAY-24 |
| P2520T | FORD                              | TUERCA FORD FOCUS RCA. 10x1,5 - LARGO 17,5mm   | MAY-24 |
| P2521T | FORD                              | TUERCA FORD FOCUS RCA. 12x1,5 - P/CAÑO 3/16" - LARGO 17,5mm                            | MAY-24 |
| P2522T | FORD                              | TUERCA FORD FOCUS RCA. 12x1,5 - P/CAÑO 1/4" - LARGO 17,5mm                             | MAY-24 |
| P2523T | FORD - TOYOTA                     | TUERCA FORD RANGER - TOYOTA RCA. 10x1 - LARGO 16mm                                     | MAY-24 |
| P2650  | VW                                | TRABA PASTILLA VW BORA - GOL - PASSAT - VENTO  | ENE-23 |
| P7203  | MITSUBISHI                        | KIT ANTIRRUIDO DEL. MITSUBISHI L200, TRITON 12/20                                      | MAY-24 |
| P9107  | FIAT - FORD                       | REGULADOR IZQUIERDO FIAT QUBO - FORD ECOSPORT  | MAR-23 |
| P9108  | FIAT - FORD                       | REGULADOR DERECHO FIAT QUBO - FORD ECOSPORT  | MAR-23 |
| P9109  | IVECO                             | REGISTRO IVECO 60.13 - 70.13V 8.5TN  | MAR-23 |
| P9110  | FIAT                              | REGISTRO FIAT DUCATO R15/16 (TODOS)  | MAR-23 |
| P9111  | MITSUBISHI                        | REGISTRO DERECHO MITSUBISHI MONTERO 89/95  | MAR-23 |
| P9112  | MITSUBISHI                        | REGISTRO IZQUIERDO MITSUBISHI MONTERO 89/95  | MAR-23 |
| P22230 | FIAT - JEEP                       | KIT ANTIRRUIDO DEL. FIAT TORO - JEEP RENEGADE, COMPASS 16/21                           | MAY-24 |
| P22598 | VW                                | KIT ANTIRRUIDO VW BORA, GOLF, NEW BEETLE, PASSAT, VENTO, ETC.                          | MAY-24 |
| P42337 | CITROEN - FIAT - PEUGEOT - TOYOTA | ANTIRRUIDO CALIPER TRASERO CITROEN JUMPER - FIAT DUCATO - PEUGEOT BOXER - TOYOTA JARIS | MAY-24 |



# LISTA DE NOVEDADES



## CILINDROS DE FRENO

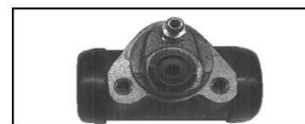

# Q

| Cód.    | Aplicación   | Año   | Med    | Sist. | Ubic.       | Imagen | Inc.   |
|---------|--|-------|--------|-------|-------------|--------|--------|
| Q454    | CIL. RDA. FORD FOCUS III   | 07/14 | 13/16" | -     | TRAS        |        | ABR-23 |
| Q6511L  | CIL. RDA LPR 4066<br>PEUGOT P206 Con Válvula<br>CONEXIÓN 12x1  |       | 3/4"   | BOSCH | TRAS<br>IZQ |        | JUL-24 |
| Q6512L  | CIL. RDA LPR 4067<br>PEUGEOT P206 Con Válvula<br>CONEXIÓN 12x1   |       | 3/4"   | BOSCH | TRAS<br>DER |        | JUL-24 |
| Q7101DL | CIL. RDA. LPR 4130<br>CHEVROLET 400 68/74 FD<br>DIESEL - CHEVY // FORD<br>F100 59/84 - F150 - FALCON<br>- FAIRLANE 69/.. |       | 7/8"   | BX    | TRAS<br>DER |        | JUL-24 |
| Q7101IL | CIL. RDA. LPR 4129<br>CHEVROLET 400 68/74 FD<br>DIESEL - CHEVY // FORD<br>F100 59/84 - F150 - FALCON<br>- FAIRLANE 69/.. |       | 7/8"   | BX    | TRAS<br>IZQ |        | JUL-24 |
| Q8501L  | CIL. RDA. LPR 4920 FORD<br>ESCORT - FIESTA CLX - KA<br>87/..<br>CONEXIÓN 10x1  | -     | 11/16" | VARGA | TRAS        |        | JUN-24 |
| Q9701IL | CIL. RDA. LPR 4537 R-9 / R-<br>11 / R-19 / CLIO<br>CONEXIÓN 10x1   | -     | 22mm   | BX    | TRAS<br>IZQ |        | JUN-24 |
| Q9701DL | CIL. RDA. LPR 4535 R-9 / R-<br>11 / R-19 / CLIO<br>CONEXIÓN 10x1   | -     | 22mm   | BX    | TRAS<br>DER |        | JUN-24 |
| Q9801L  | CIL. RDA. LPR 4452 FIAT<br>DUNA - UNO - REGATTA<br>Rca. 10x1   |       | 3/4"   | VARGA | TRAS        |        | JUL-24 |



# LISTA DE NOVEDADES

| Cód.   | Aplicación  | Año   | Med    | Sist. | Ubic. | Imagen | Inc.   |
|--------|---|-------|--------|-------|-------|--------|--------|
| Q9901L | CIL. RDA. LPR 4913<br>VOLKSWAGEN CARAT -<br>GACEL - GOL - PASSAT -<br>SANTANA - SENDA | -     | 9/16"  | VARGA | TRAS  |        | JUN-24 |
| Q9905  | CIL. RDA. FIAT DOBLO -<br>500 // VW POLO - T-CROSS                                    | 17/.. | 13/16" | -     | TRAS  |        | ABR-23 |
| Q9906  | CIL. RDA. VW NVO POLO<br>RCA: 10x1  | 18/.. | 3/4"   | -     | TRAS  |        | ABR-23 |
| Q10111 | CIL. RDA. NISSAN<br>FRONTIER<br>RCA: 10x1 C/CONO                                      | -     | 1"     | -     | TRAS  |        | ABR-23 |
| Q10112 | CIL. RDA. NISSAN SENTRA   | -     | 5/8"   | -     | TRAS  |        | ABR-23 |
| Q10113 | CIL. RDA. NISSAN KICKS -<br>VERSA<br>RCA: 10x1 C/CONO                                 | 16/23 | 3/4"   | -     | T/IZQ |        | NOV-23 |
| Q10114 | CIL. RDA. NISSAN KICKS -<br>VERSA<br>RCA: 10x1 C/CONO                                 | 16/23 | 3/4"   | -     | T/DER |        | NOV-23 |
| Q18002 | CIL. RDA. HONDA CIVIC<br>CRV - CRX  | -     | 13/16" | -     | T/IZQ |        | JUN-23 |
| Q18003 | CIL. RDA. HONDA CIVIC<br>CRV - CRX  | -     | 13/16" | -     | T/DER |        | JUN-23 |
| Q18004 | CIL. RDA. HONDA CIVIC<br>CRV - CRX  | -     | 3/4"   | -     | T/IZQ |        | JUN-23 |







# LISTA DE NOVEDADES

| Cód.    | Aplicación   | Año | Med    | Sist.  | Ubic. | Imagen | Inc.   |
|---------|--|-----|--------|--------|-------|--------|--------|
| Q18005  | CIL. RDA. HONDA CIVIC CRV - CRX  | -   | 3/4"   | -      | T/DER |        | JUN-23 |
| Q18006  | CIL. RDA. HONDA CITY - FIT   | -   | 3/4"   | -      | TRAS  |        | JUL-23 |
| Q31201  | VÁLV. LIMITADORA NISSAN VERSA - TIIDA  | -   | -      | -      | -     |        | ABR-24 |
| Q81001L | CIL. RDA LPR 4258 FORD ESCORT - FIESTA - FOCUS - ORION // VW POINTER<br>CONEXIÓN 10x1                | -   | 3/4"   | VARGA  | TRAS  |        | JUN-24 |
| Q81601L | CIL. RDA. LPR 4475 FIAT DUNA - UNO - REGATTA - 147 Autorregulable<br>RCA: 10x1                       | -   | 3/4"   | VARGA  | TRAS  |        | JUL-24 |
| Q82601L | CIL RDA. LPR 4484 FIAT PALIO - SIENA - TEMPRA - FIORUNO<br>CONEXIÓN 10x1                             | -   | 13/16" | ATE    | TRAS  |        | JUN-24 |
| Q82901L | CIL. RDA. LPR 4912 - FORD GALAXY // SEAT CORDOBA // VW POLO - SAVEIRO - SURAN - FOX - GOLF - QUANTUM | -   | 11/16" | ATE    | TRAS  |        | JUN-24 |
| Q84301L | CIL. RDA. LPR 4248 - CHEVROLET ASTRA - CORSA - VECTRA  | -   | 3/4"   | VARGA  | TRAS  |        | JUN-24 |
| Q84901L | CIL. RDA. LPR 4489 FIAT PALIO - SIENA Base Triangular<br>CONEXIÓN 10x1                               | -   | 3/4"   | ATE    | TRAS  |        | JUL-24 |
| Q85201L | CIL. RDA. LPR 4595 RENAULT MEGANE 1.6 1.9TD 2.0<br>CONEXIÓN 10x1                                     | -   | 11/16" | BENDIX | TRAS  |        | JUL-24 |







# LISTA DE NOVEDADES

| Cód.    | Aplicación  | Año   | Med    | Sist. | Tipo | Imagen | Inc.   |
|---------|---|-------|--------|-------|------|--------|--------|
| Q85401L | CIL. RDA. LPR 4876<br>CITROEN BERLINGO //<br>PEUGEOT PARTNER  | -     | 7/8"   | LUCAS | TRAS |        | JUN-24 |
| Q85802L | CIL. RDA. LPR 4078<br>RENAULT LOGAN - CLIO II<br>M/N - SYMBOL | -     | 11/16" | -     | TRAS |        | JUL-24 |
| Q85810  | CIL. RDA. RENAULT KWID  | 17/.. | 5/8"   | -     | TRAS |        | ABR-23 |
| Q85811  | CIL. RDA. RENAULT<br>ALASKAN 2.3 DCI 4x4                      | -     | 7/8"   | -     | TRAS |        | ABR-24 |



**BBAS. EMBRAGUE, FRENO Y CIL.  
AUX. NACIONAL - IMPORTADO**



**QB  
QR  
QS**

| Cód.  | Aplicación   | Año   | Med    | Sist. | Tipo | Imagen | Inc.   |
|-------|--|-------|--------|-------|------|--------|--------|
| QB039 | CRAPODINA HIDRAULICA<br>DE EMBRAGUE<br>MERCEDES BENZ 712 - 914<br>- 1215 - 1620 - ATEGO -<br>AXOR  | VER   | 23mm   |       |      |        | DIC-22 |
| QB040 | CRAP. HIDR. EMBR. FORD<br>KUGA 2.5T 09/14 - MONDEO<br>2.5T 07/14 // LAND ROVER<br>FREELANDER II 2.2 DIESEL<br>06/..  | VER   | Ø 31mm |       |      |        | SEP-22 |
| QB041 | CRAPODINA HIDRAULICA<br>DE EMBRAGUE<br>(PLÁSTICO) CHEVROLET<br>CRUZE 1.4T  | 16/.. | Ø 27mm |       |      |        | SEP-22 |
| QB042 | CRAP. HIDR. EMBR. CITROEN<br>C4 GRAND PICASSO 1.6 THP,<br>1.6 HDI - C4 LOUNGE 1.6 THP,<br>1.6 HDI 13/.. - DS3 1.6 THP -<br>DS4 1.6 THP // PEUGEOT 208<br>1.6 THP - 308 1.6 THP, 1.6 HDI -<br>408 1.6 THP, 1.6 HDI - 2008 1.6<br>THP - 3008 1.6 THP | VER   | Ø 24mm |       |      |        | SEP-22 |



# LISTA DE NOVEDADES

| Cód.    | Aplicación  | Año   | Med    | Sist. | Tipo | Imagen | Inc.   |
|---------|---|-------|--------|-------|------|--------|--------|
| QB043   | CRAP. HIDR. EMBR. CITROEN C4 GRAND PICASSO 1.6 THP, 1.6 HDI - C4 LOUNGE 1.6 THP, 1.6 HDI 13/.. - DS3 1.6 THP - DS4 1.6 THP // PEUGEOT 208 1.6 THP - 308 1.6 THP, 1.6 HDI - 408 1.6 THP, 1.6 HDI - 2008 1.6 THP - 3008 1.6 THP | VER   | Ø 23mm |       |      |        | SEP-22 |
| QB044   | CRAPODINA HIDRAULICA DE EMBRAGUE TOYOTA COROLLA 09/.. - ETIOS 16/..   | VER   | Ø 28mm |       |      |        | SEP-22 |
| QB046   | CRAPODINA HIDRAULICA DE EMBRAGUE (CAÑO LARGO) NISSAN TIIDA 08/.. - X-TRAIL 11/.. // RENAULT DUSTER 11/.. - FLUENCE 10/.. - KOLEOS 09/.. - MEGANE III 11/..<br><b>CONEXIÓN: ENCHUFAR</b>                                       | VER   | 5/8"   |       |      |        | AG-22  |
| QB055   | CRAPODINA HIDRAULICA DE EMBRAGUE FIAT TORO 16/.. - TORO 2.0 // JEEP COMPASS 17/.. - RENEGADE 16/..  | VER   | 23mm   |       |      |        | DIC-22 |
| QB3110  | BOMBA DE EMBRAGUE HYUNDAI TUCSON // KIA SPORTAGE  | 10/.. | 5/8"   |       |      |        | SEP-22 |
| QB10250 | BOMBA DE EMBRAGUE TOYOTA COROLLA 09/.. - ETIOS 12/..  | VER   | 5/8"   |       |      |        | SEP-22 |
| QB12300 | BBA. EMBRAGUE NISSAN SENTRA 13/16 - TIIDA 07/15 - VERSA 13/15   | VER   | 5/8"   |       |      |        | JUL-23 |
| QB12301 | BBA. EMBRAGUE NISSAN MARCH 12/.. - NOTE 15/.. - VERSA 15/20   | VER   | 5/8"   |       |      |        | JUL-23 |
| QB13610 | BBA. EMBRAGUE (CAJA AUTOMÁTICA EASYTRONIC) CHEVR. CORSA II - MERIVA   | 03/.. |        |       |      |        | SEP-22 |







# LISTA DE NOVEDADES

| Cód.    | Aplicación   | Año   | Med    | Sist. | Tipo | Imagen | Inc.   |
|---------|--|-------|--------|-------|------|--------|--------|
| QB13611 | BBA. EMBRAGUE<br>CHEVROLET CRUZE 1.4<br>TURBO  | 16/.. | 5/8"   |       |      |        | SEP-23 |
|         | <i>CONEXIÓN: ENCHUFAR</i>  |       |        |       |      |        |        |
| QB15605 | BOMBA DE EMBRAGUE<br>FORD ECOSPORT 12/17 -<br>ECOSPORT 17/.. - FIESTA<br>KINETIC 10/.. | VER   | 5/8"   |       |      |        | SEP-22 |
|         | <i>CONEXIÓN: ENCHUFAR</i>  |       |        |       |      |        |        |
| QB17103 | BBA. EMBRAGUE SUZUKI<br>SWIFT  | 08/.. | 5/8"   |       |      |        | AG-22  |
|         | <i>CONEXIÓN: ENCHUFAR</i>  |       |        |       |      |        |        |
| QB17104 | CILINDRO AUXILIAR DE<br>EMBRAGUE SUZUKI SWIFT  | 08/.. | 13/16" |       |      |        | AG-22  |
|         | <i>CONEXIÓN: ENCHUFAR</i>  |       |        |       |      |        |        |
| QB17203 | BBA. EMBRAGUE SUZUKI<br>GRAND VITARA JIII  | 08/.. | 5/8"   |       |      |        | AG-22  |
|         | <i>CONEXIÓN: ENCHUFAR</i>  |       |        |       |      |        |        |
| QB19100 | BBA. EMBRAGUE DODGE<br>JOURNEY 08/.. // JEEP<br>COMPASS 06/.. - PATRIOT<br>07/..       | VER   | 11/16" |       |      |        | AG-22  |
|         | <i>CONEXIÓN: ENCHUFAR</i>  |       |        |       |      |        |        |
| QB23503 | BBA. FRENO C/DEPOSITO<br>VW GOL TREND<br>SAVEIRO TREND<br>MOTOR MSI                    | 14/.. | 7/8"   | DC    |      |        | SEP-23 |
|         | <i>CONEXIÓN 2 - 10x1 // 2 - 12x1</i>   |       |        |       |      |        |        |
| QB24108 | BOMBA DE EMBRAGUE<br>NISSAN XTRAIL 08/14 //<br>RENAULT KOLEOS 09/15                    | VER   | 5/8"   |       |      |        | SEP-22 |
|         | <i>CONEXIÓN: ENCHUFAR</i>  |       |        |       |      |        |        |
| QB24109 | BOMBA DE EMBRAGUE<br>RENAULT DUSTER -<br>DUSTER OROCH                                  | -     | 5/8"   |       |      |        | SEP-22 |
|         | <i>CONEXIÓN: ENCHUFAR</i>  |       |        |       |      |        |        |
| QB24110 | BBA. EMBRAGUE RENAULT<br>LOGAN 13/.. - SANDERO<br>15/.. - STEPWAY 15/..                | VER   | 5/8"   |       |      |        | AG-22  |
|         | <i>CONEXIÓN: ENCHUFAR</i>  |       |        |       |      |        |        |





# LISTA DE NOVEDADES

| Cód.    | Aplicación   | Año   | Med    | Sist. | Tipo | Imagen  | Inc.   |
|---------|--|-------|--------|-------|------|---|--------|
| QB24111 | BBA. EMBRAGUE RENAULT<br>FLUENCE - MEGANE II   |       | 5/8"   |       |      |    | ENE-24 |
|         | CONEXIÓN: ENCHUFAR   |       |        |       |      |   |        |
| QB25104 | BBA. EMBRAGUE FIAT<br>TORO // JEEP RENEGADE  |       | 5/8"   |       |      |    | JUL-23 |
|         | CONEXIÓN: ENCHUFAR   |       |        |       |      |   |        |
| QB25105 | BBA. EMBRAGUE FIAT<br>LINEA - PUNTO  | 08/.. | 5/8"   |       |      |    | AG-22  |
|         | CONEXIÓN: ENCHUFAR   |       |        |       |      |   |        |
| QB25106 | BOMBA DE EMBRAGUE<br>FIAT ARGO - CRONOS -<br>GRAND SIENA - PALIO<br>NOVO - UNO FASE II 10/.. | -     | 5/8"   |       |      |    | SEP-22 |
|         | CONEXIÓN: ENCHUFAR   |       |        |       |      |   |        |
| QB29101 | BOMBA DE EMBRAGUE<br>CITROEN C4 // PEUGEOT<br>307 - 308                                      | -     | 5/8"   |       |      |   | SEP-22 |
|         | CONEXIÓN: ENCHUFAR   |       |        |       |      |   |        |
| QB32101 | BOMBA DE EMBRAGUE<br>(ALUMINIO) CHERY TIGGO<br>1.6   | 08/16 | 5/8"   |       |      |  | SEP-22 |
| QB32102 | BBA. EMBRAGUE<br>(ALUMINIO + PLÁSTICO)<br>CHERY TIGGO 2.0                                    | 08/16 | 3/4"   |       |      |  | SEP-22 |
| QB32103 | CILINDRO AUXILIAR DE<br>EMBRAGUE CHERY TIGGO   | 08/13 | 13/16" |       |      |  | SEP-22 |
|         | CONEXIÓN: M10x1  |       |        |       |      |   |        |
| QR4207  | BBA. EMBR. FORD CARGO  | 11/.. | 1"     |       |      |  | ABR-23 |
| QR4208  | BBA. EMBRAGUE FORD<br>TRANSIT  | 00/06 | 5/8"   |       |      |  | JUL-24 |









# LISTA DE NOVEDADES

| Cód.    | Aplicación   | Año   | Med     | Sist. | Tipo | Imagen | Inc.   |
|---------|--|-------|---------|-------|------|--------|--------|
| QR4401  | CIL. AUX. EMBR. FORD TRANSIT   | -     | 13/16"  |       |      |        | JUL-24 |
| QR4407  | CIL. AUX. EMBR. FORD CARGO   | -     | 1 1/8"  |       |      |        | ABR-23 |
| QS2003  | BBA. FRENO DC TOYOTA HILUX - SW4 2.4 - 2.8<br>2 SAL.: 12x1 C/CONO                                    | 15/.. | 7/8"    |       |      |        | NOV-23 |
| QS06268 | BBA. FRENO FORD RANGER 2.2TDCI - 2.5N - 3.2TDCI 4x2 - 4x4 MT<br>2 SAL.: 10x1                         | 12/16 | 7/8"    |       |      |        | ENE-24 |
| QS06269 | BBA. FRENO FORD RANGER 2.2TDCI - 2.5N - 3.2TDCI 4x2 - 4x4 MT<br>2 SAL.: 12x1                         | 12/16 | 7/8"    |       |      |        | MAR-24 |
| QS07120 | BBA. FRENO DC CHEVROLET S10 2.8 LS/LT/LTZ (MANUAL)<br>2 SAL.: 10x1                                   | 12/17 | 7/8"    | BOSCH |      |        | ABR-23 |
| QS07121 | BBA. FRENO DC CHEVROLET S10 2.8 LS/LT/LTZ (AUTOMÁTICO)<br>2 SAL.: 12x1                               | 12/17 | 7/8"    | BOSCH |      |        | ABR-23 |
| QS13115 | BBA FRENO M. BENZ VITO 111 - FURGON 119 - COMBI 121 - TOURER C/ABS<br>2 SAL.: 12x1                   | 15/.. | 1 1/16" | TRW   |      |        | SEP-23 |
| QS16214 | BBA. FRENO CITROEN BERLINGO - XSARA // PEUGEOT 306 - PARTNER // (todos c/ABS)<br>2 SAL.: 10x1 - 12x1 | 97/15 | 15/16"  | ATE   |      |        | MAY-22 |
| QS18110 | BBA. FRENO RENAULT CLIO II - KANGOO - KANGOO EXPRESS C/ABS<br>2 SAL.: 10x1 - 12x1                    | 97/08 | 7/8"    | BOSCH |      |        | JUN-22 |





# LISTA DE NOVEDADES

| Cód.    | Aplicación  | Año   | Med     | Sist. | Tipo | Imagen  | Inc.   |
|---------|---|-------|---------|-------|------|---|--------|
| QS18158 | BBA. FRENO RENAULT KWID                               | 17/.. | 3/4"    | BOSCH |      |  | AG-23  |
|         | 2 SAL.: 10x1  |       |         |       |      |   |        |
| QS18159 | BBA. FRENO RENAULT MEGANE II - SCENIC II              |       | 15/16"  | -     |      |  | MAY-23 |
|         | 2 SAL.: 12x1  |       |         |       |      |   |        |
| QS21230 | BBA. FRENO VW AMAROK 2.0TDI (ALUMINIO - SIN DEPOSITO) | 10/16 | 1 1/16" |       |      |  | ENE-24 |
|         | 2 SAL.: 12x1  |       |         |       |      |   |        |





# LISTA DE NOVEDADES

## (1254) RD12484M

CHEVROLET TRACKER 17/..

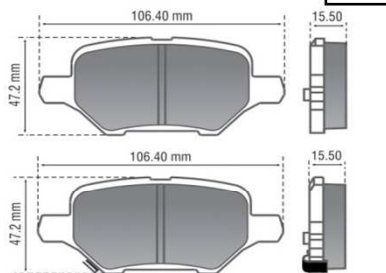

## (1079) RD12485M

AUDI Q5 08/.. - A4 08/12 - A5 08/12

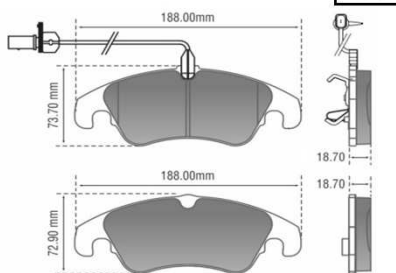

## (1236) RD12486

CHEVROLET ONIX 1.0 TURBO 19/..

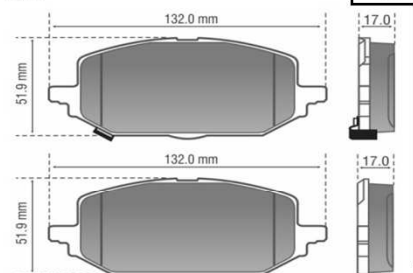

## (1175) RD12488

KIA PICANTO 11/..

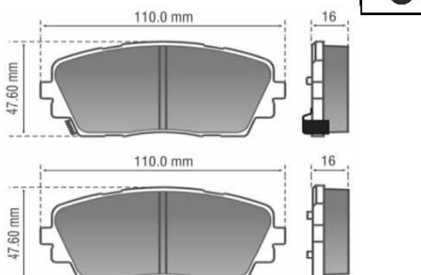

## (0916) RD12495M

CITROEN JUMPY II 1.6 + 2.0 HDI 07/.. - SPACE TOURER 06/.. // FIAT SCUDO II 1.6 - 2.0 07/.. // PEUGEOT EXPERT 06/.. - EXPERT II TEPEE 1.6 - 2.0 07/..

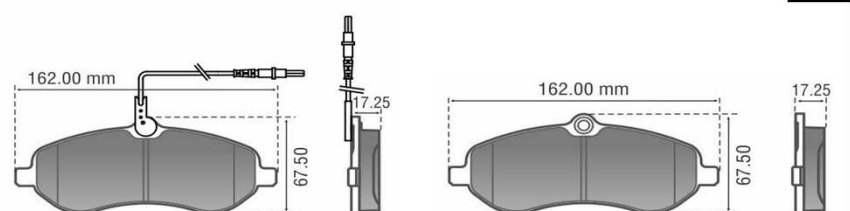

## (0899) RD12497M

HYUNDAI CRETA 1.6 - 2.0 ATTITUDE - PULSE - PRESTIGE 16/.. - I30 - I30 CW 1.4 - 1.6 - 2.0 07/.. // KIA CARENS II EX LX- CRDI 1.6 - 1.8 - 2.0 02/.. CERATO 1.6 - 2.0 EX FORTE 10/.. - SOUL II 1.6 - 2.0 CVVT 14/..

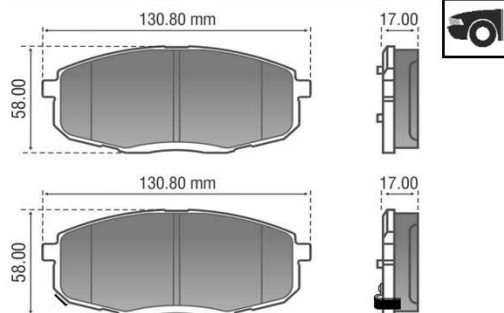

## RD12498M

MERCEDES BENZ ACTROS 1841 14/17 - ACTROS 2531 13/14 - ACTROS 2636 12/14 - ACTROS 1841 LS 15/.. - ACTROS 1846 LS 15/.. - ACTROS 2041 S 11/.. - ACTROS 2042 S 18/.. - ACTROS 2044 S 11/14 - ACTROS 2046 S 13/.. - ACTROS 2048 LS 18/.. - ACTROS 2051 LS 18/.. - ACTROS 2645 LS 19/.. - ACTROS 2646 LS 19/.. - ACTROS 2646 S/LS 11/17 - ACTROS 2655 LS 17/..

## RD12499M

MERCEDES BENZ ACTROS 1841 14/17 - ACTROS 2531 13/14 - ACTROS 2636 12/14 - ACTROS 1841 LS 15/.. - ACTROS 1846 LS 15/.. - ACTROS 2041 S 11/.. - ACTROS 2042 S 18/.. - ACTROS 2044 S 11/14 - ACTROS 2046 S 13/.. - ACTROS 2048 LS 18/.. - ACTROS 2051 LS 18/.. - ACTROS 2645 LS 19/.. - ACTROS 2646 LS 19/.. - ACTROS 2646 S/LS 11/17 - ACTROS 2655 LS 17/..

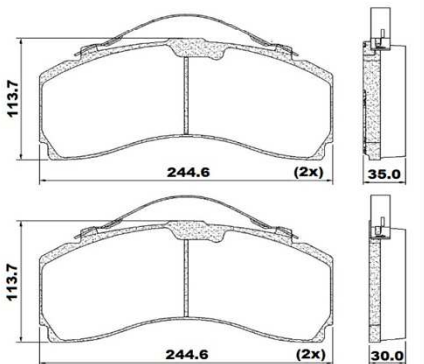
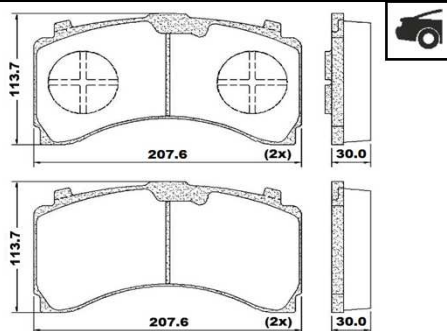

## (0520) RD12500M

IVECO EURO RIDER 99/.. // M. BENZ ACTROS 1938 98/.. // SCANIA K-124 - 230 - 270 - 310 - 340 - 380 4x2 08/.. - SERIE 4 R144 LB 99/.. - SERIE 4 T124 6B 99/.. // KNORR

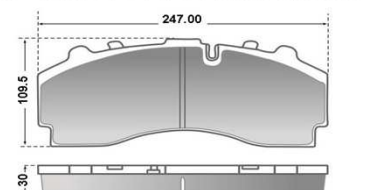

## (1071) RD12506M

AUDI A3 II - S3 1.4 TSI - 1.8 - 2.0 TDI 12/.. - Q2 TFSI 2.0 QUATTRO 16/.. // SEAT ALHAMBRA II 1.4 TSI - 2.0 TDI 16V 4WD 10/.. // VW GOLF VII 1.4 TSI - 2.0 GTI 18/.. - PASSAT CC 2.0 TSI - 3.6 TFSI 08/.. - SHARAN II 1.4 TSI - 2.0 TDI 16V 4WD 10/.. - TIGUAN II 1.4 TSI - 2.0 TDI 17/..

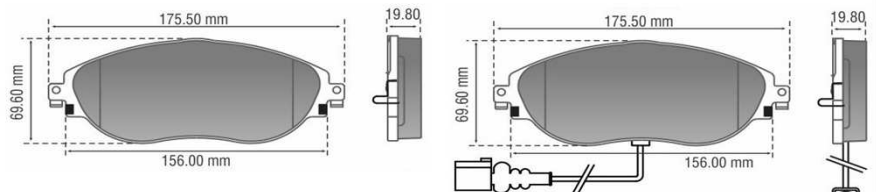



**(1131) RD12511M**

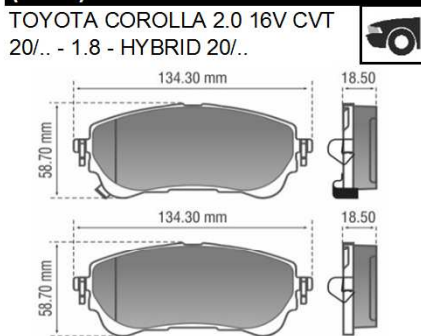

**(1250) RD12512M**

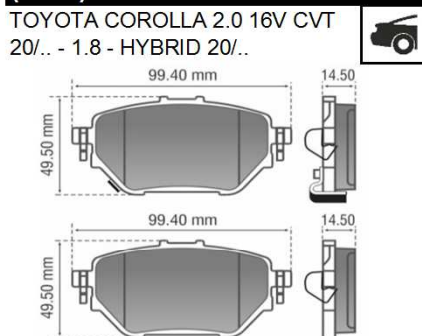

**RD12513M**

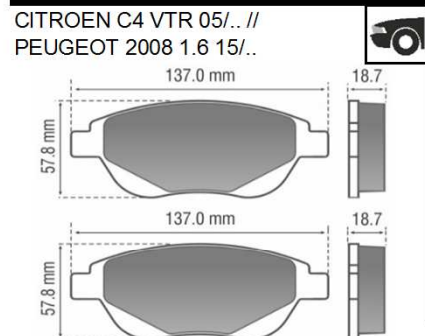

**(0989) RD12522M**

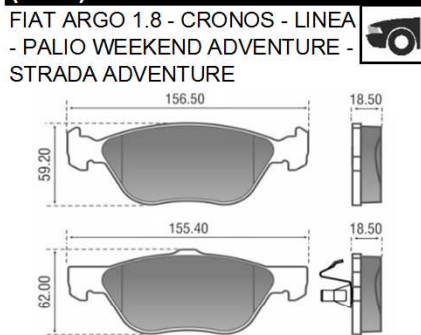

**(1080) RD12523M**

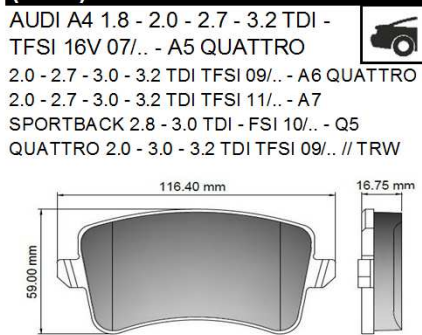

**RD12524M**

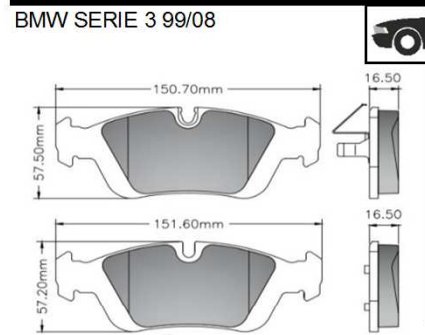

**RD12526M**

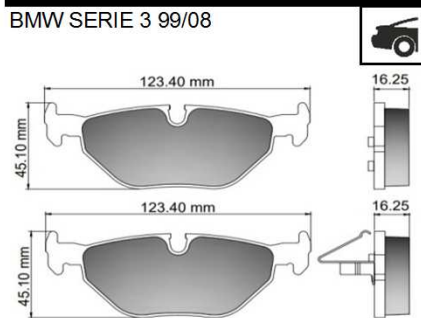

**(1149) RD12527M**

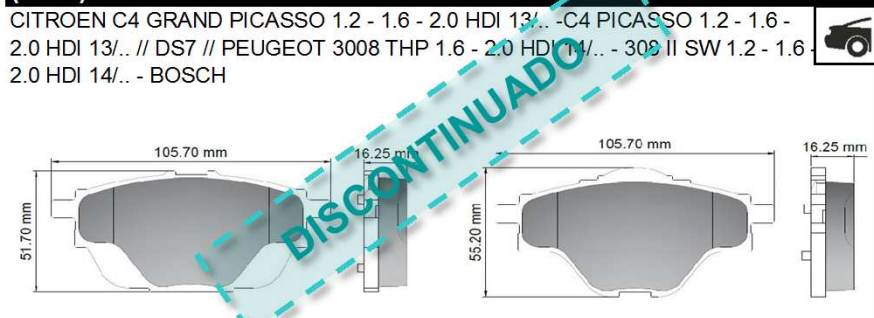

**(1206) RD12530M**

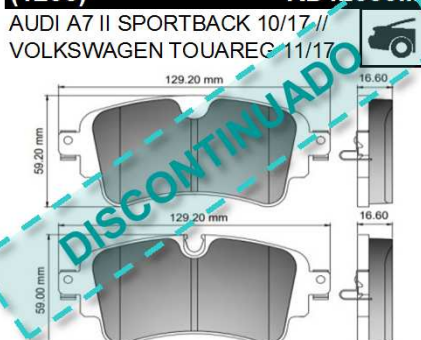

**RD12531M**

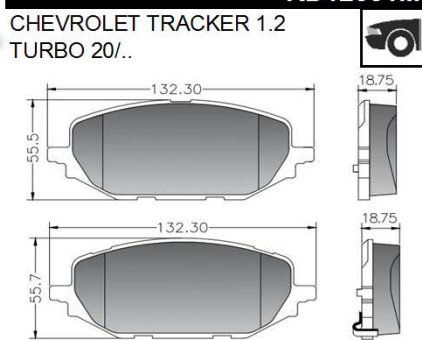

**RD12532M**

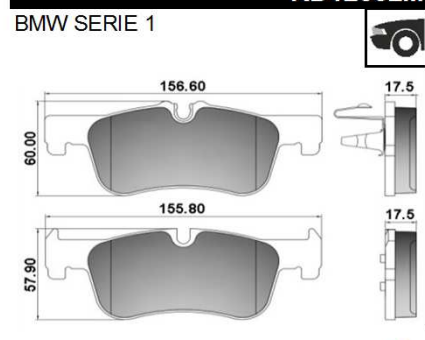

**RD12533M**

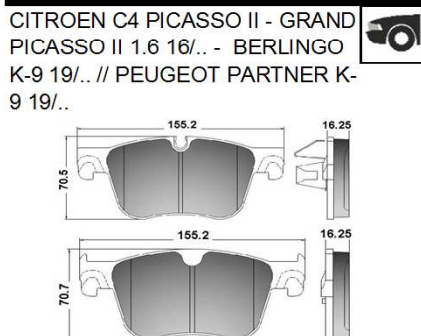

**(1246) RD12535M**

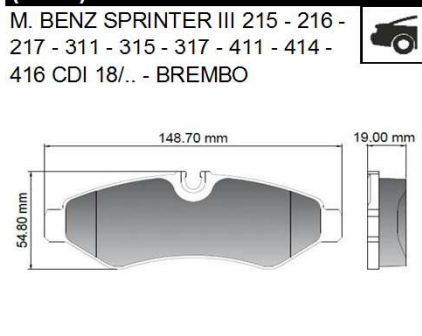

**(1260) RD12536M**





# LISTA DE NOVEDADES

## (0952) RD12537M

HONDA CITY - FIT - WR-V EX - EXL 1.5

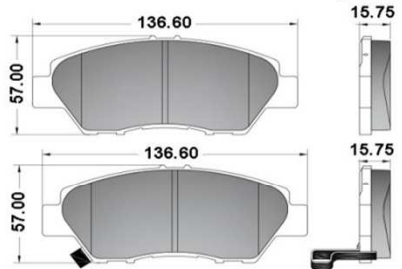

## RD12544M

BMW SERIE 3 (E90 - E91 - E92) 06/12 - X1 (E84) 10/14

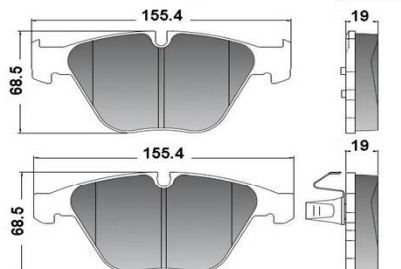

## RD12548M

CHEVROLET EQUINOX 1.5 18/.. LLANTA 17"

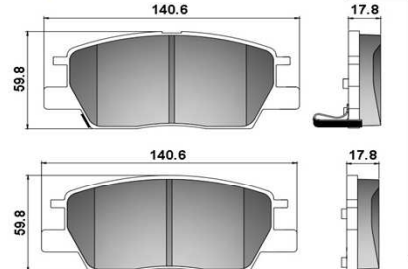

## RD12549M

CHEVROLET EQUINOX 1.5 TURBO 18/..

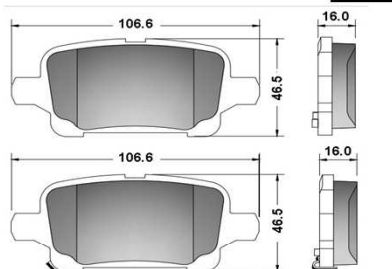

## RD12550M

CITROEN C4 - C5 - DS4 // PEUGEOT 308 - 508 - RCZ

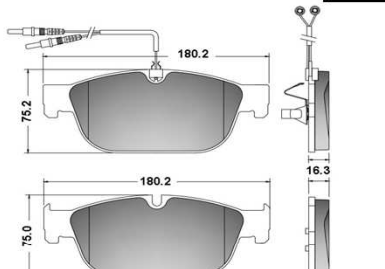

## RD12552M

BMW X1 15/.. - BMW 2 ACTIVE // MINI CLUBMAN

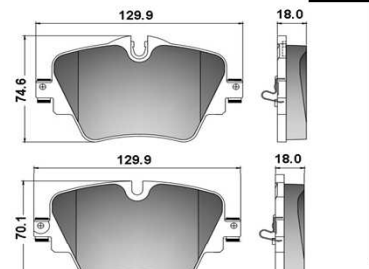

## RD12553M

BMW X1 15/.. - BMW 2 ACTIVE // MINI CLUBMAN

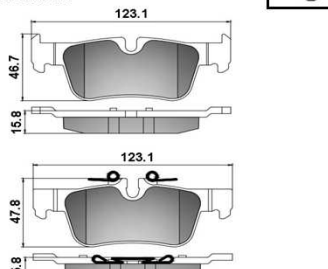

## RD12554M

CITROEN C4 - C4 PICASSO - BERLINGO // PEUGEOT 5008 - PARTNER // DS4

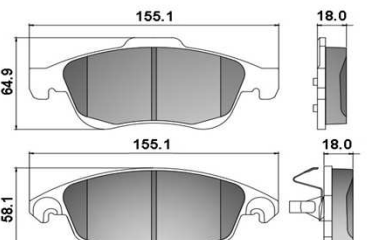

## RD12555

CITROEN C4 // PEUGEOT 207 - 207SW - 307

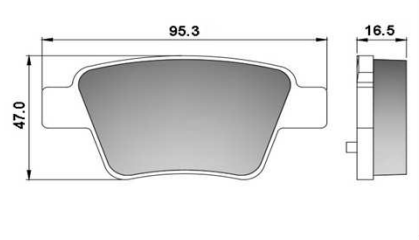

## (0979) RD12959AM

A. ROMEO 156 2.0 00/02 // FIAT LINEA 1.4, 1.8 08/.. - BRAVO 11/..

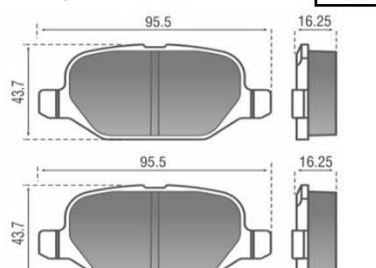

## (0852) RD12902AM

M. BENZ ACCELO 915-C 16/.. - ATEGO I 1017 a 1023 - 712 a 717 - 812 a 823 - 917 a 923 98/..

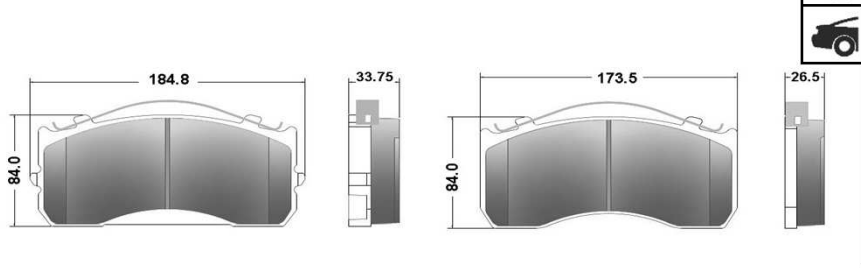

## (1219) RD12972M

MB SPRINTER 3.5 - 3T. - 4.6T. - 5T. - VITO NVA. APLIC.

