



# LISTA DE NOVEDADES

## INCOPORACIONES AL:



CATALOGO GENERAL



CATALOGO CHAJA



CATALOGO BOMBAS Y CILINDROS



CATALOGO PASTILLAS DE FRENO



CATALOGO TREN DELANTERO



Av. Mitre 1293 - (1878) Quilmes, Bs. As. - Rep. Argentina - WWW.ITALFREN.COM.AR - info@italfren.com.ar

(011) 7504-4545 / 4618 (Telecentro) - (011) 5057-8417 Whatsapp

Fax s/cargo 0800-222-2047



# LISTA DE NOVEDADES



## REPARACIONES DE FRENOS A DISCO



Cód.	Med.	Aplicación	Ilustración	Incorp.
C3033	80mm	REP. CALIPER DELANTERO DODGE RAM 2500		JUN-23
C3093	45mm	REP. CALIPER DEL. RENAULT MASTER // MB. SPRINTER - BOSCH		OCT-22
C3201	36mm	REP. CALIPER TRASERA TOYOTA COROLLA		OCT-22
C3202	38mm	REP. CALIPER TRASERO PEUGEOT 307/308 - CITROEN C4		JUN-23
C4612	38mm	REP. CALIPER TRASERA COMPLETA (GOMA+METAL) CITROEN C5 // FORD FOCUS - FOCUS C-MAX - KUGA // RENAULT LAGUNA - MEGANE // VOLVO S40 - V50		OCT-22
C10142	48mm	REP. CALIPER TRASERA VOLKSWAGEN AMAROK V6		MAR-24
C10144	48mm	REP. CALIPER TRASERA FORD TRANSIT		MAR-24



## JUEGOS DE PERNOS GUIA P/CALIPERS Y SUS PARTES



Código	Aplicación	Imagen	Sist.	Ubic.	Medida	Incorp
D7216S	KIT PERNOS DESLIZ. C/FUELLES FORD EXPLORER - F-150 97/02 - RANGER - SUPERMEDIDA		BENDIX	-	70,3 x 10,5	ABR-24



# LISTA DE NOVEDADES

Código	Aplicación	Imagen	Sist.	Ubic.	Medida	Incorp
D7787	KIT BUJES DE CALIPERS MERCEDES BENZ SPRINTER 411 - 414 19/..		BREMBO	DEL. TRAS.	BUJE 63 x 18 PERNO 12 x 84	MAR-24
D7864	<b>NUEVA APLICACIÓN:</b> KIT PERNOS DE CALIPER FORD FIESTA KINETIC DESIGN				70 x 9,5	OCT-22
D7871	KIT DE PERNOS DESLIZ. C/ FUELLES PEUGEOT 206 - 306		BOSCH	-	68,50x10	AG-22
D7872	KIT DE PERNOS DESLIZANTES C/FUELLES HYUNDAI TUCSON 12/.. - KIA SPORTAGE 12/..		-	-	72x9,85	AG-22
D8081	KIT PERNOS CHEVROLET AVEO		-	-	59x10	AG-22
D8084	KIT BUJES C/RECTIFICADO Y CROMO DURO IVECO 70C16 - 70HD		-	-	90x22	AG-22
D8084/K	KIT BUJES C/RECTIFICADO Y CROMO DURO + TORNILLOS IVECO 70C16 - 70HD		-	-	90x22 120x12	AG-22
D8084/KF	KIT BUJES C/RECTIFICADO Y CROMO DURO + TORNILLOS C/FUELLES IVECO 70C16 - 70HD (KIT COMPLETO)		-	-	90x22 120x12	AG-22
D8086	KIT PERNOS Y FUELLES - COMPLETO- RENAULT MASTER II 12/..		BREMBO		80x18	ABR-24





# LISTA DE NOVEDADES

Código	Aplicación	Imagen	Sist.	Ubic.	Medida	Incorp
D8092	KIT VOLKSWAGEN AMAROK		-	TRAS	77 alt. 9,9 diam.	MAY-24



## REPARAC. DE SERVO NACIONAL - IMPORTADO



Código	Sist.	Imagen	Aplicación	Incorp
E1024D	TRW LUCAS GIRLING		DIAFRAGMA PARA SERVO SIMPLE FORD COURIER - FIESTA - KA // DIAM. EXT. 240mm - AGUJ. INT. 55mm	ABR-24
E1030	ATE		JGO. REP. SERVO RENAULT LOGAN - SANDERO	ABR-23
E1177	ATE		JUEGO DE REPARACIONES P/SERVO DT CHEVROLET CRUZE	AG-22
E1177DA	ATE		DIAFRAGMA SUPERIOR CHEVROLET CRUZE (similar a diafragma VW Amarok pero más chico) // Ø EXT.: 224mm - Ø AGUJ.: 35mm - ENTRECENROS 100mm	-
E1177DB	ATE		DIAFRAGMA INFERIOR CHEVROLET CRUZE (similar a diafragma VW Amarok pero más chico) // Ø EXT.: 241mm - Ø AGUJ.: 58mm - ENTRECENROS 100mm	-
E1178	AISIN		JUEGO REP. PARA SERVO SIMPLE TOYOTA COROLLA - E120 - FUNCARGO - VITZ	AG-22
E1178D	AISIN		DIAFRAGMA PARA SERVO SIMPLE TOYOTA COROLLA - E120 - FUNCARGO - VITZ // Ø EXT.: 241mm - Ø AGUJ.: 38mm	-
E1179	TRW		JUEGO REP. PARA SERVO SIMPLE CHEVROLET CRUZE - OTROS	AG-22





# LISTA DE NOVEDADES

Código	Sist.	Imagen	Aplicación	Incorp
E1179D	TRW		DIAFRAGMA PARA SERVO SIMPLE CHEVROLET CRUZE - OTROS (similar al E1155D, tetones grandes) // Ø EXT.: 270mm - Ø AGUJ.: 52mm - ENTRECENROS 105mm	-
E1180	ATE		JUEGO REP. PARA SERVO VW PASSAT - TIGUAN	OCT-23
E1180D	ATE		DIAFRAGMA PARA SERVO VW PASSAT - TIGUAN // Ø EXT.: 290mm	OCT-23
E1181	KDAC		JUEGO REP. SERVO CHEVROLET SPIN (CON TETONES) // Ø EXT.: 265mm	ABR-24
E1181D	KDAC		DIAFRAGMA PARA SERVO CHEVROLET SPIN (CON TETONES) // Ø EXT.: 265mm	OCT-23
E5476	ATE		DIAFRAGMA RENAULT LOGAN - SANDERO // Ø EXT.: 236mm	ABR-23



## DESPIECE Y REPARAC. SERVO TENSA

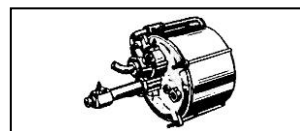

# F

Cód.	Imagen	Descripción	Incorp.
FT9629/1		VALVULA RETENCION SERVO TENSA - ORIGINAL P/CURVO	MAY-24



## PISTONES PARA CALIPERS

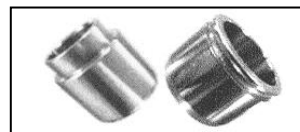

# G

Cód.	Ø	Alt.	Descripción	Sistema	Imagen	Incorp
G01036	36	49	TOYOTA COROLLA 06/.. (TRASERO)	-		OCT-22





# LISTA DE NOVEDADES

Cód.	Ø	Alt.	Descripción	Sistema	Imagen	Incorp
G01039	54	51	FIAT GRAND SIENA FORD ECOSPORT	-		AG-22
G01041	57	56	A. ROMEO GIULIETTA // AUDI A4 - A5 - Q3 // BMW SERIE 3 - XI - Z4 // CITROEN C4 // FIAT DOBLO - 500 // FORD C-MAX - FOCUS - KUGA - MONDEO - TRANSIT // HONDA ACCORD - CIVIC // IVECO DAILY	-		AG-22
G01042	34	46	HYUNDAI TUCSON (TRASERO) KIA SPORTAGE (TRASERO)	-		AG-22
G01043	48	54	RENAULT MASTER II 12/.. (TRASERO)	-		OCT-22
G01044	30	44	HONDA CITY - FIT 10/.. (TRASERO)			AG-23
G01045	54	48	HONDA CITY - FIT 10/.. (TRASERO)	-		OCT-22



## FLEXIBLES PARA FRENOS

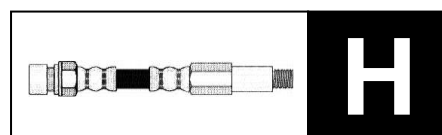

Código	Imagen	Descripción	Incorp.	Código	Imagen	Descripción	Incorp.
<b>CHEVROLET</b>							
H4124		CRUZE 17/..   DEL/DER	MAY-24	H4125		CRUZE 17/..   DEL/IZQ	MAY-24
H4136		ONIX PLUS LT 20/..   DEL/DER	MAY-24	H4137		ONIX PLUS LT 20/..   DEL/IZQ.	MAY-24
H4138		ONIX LT, LTZ ONIX PLUS LT, L 20/..   TRAS	MAY-24	H4145		AGILE 10/17 CLETA 10/15 VER   TRAS	MAY-24
H4114/1		ONIX 13/.. - PRISMA - SPIN 12/.. VER   DEL.	OCT-22	H4121		TRACKER (FRENO A TAMBOR) 13/..   TRAS	OCT-22



















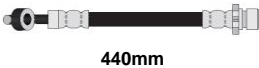
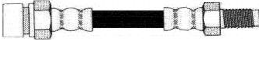

# LISTA DE NOVEDADES

Código	Imagen	Descripción	Incorp.	Código	Imagen	Descripción	Incorp.
<b>FIAT</b>							
H9138		500X 14/.. DEL.	OCT-22	H9140		500X 14/.. TRAS.	OCT-22
H2130		ARGO 17/.. - CRONOS 18/.. - MOBI 17/.. VER DEL.	MAY-24	H2137		ARGO - CRONOS - FASTBACK - PULSE TRAS	MAY-24
H2039		MOBI 16/.. TRAS	MAY-24	H2114		PUNTO 09/.. DEL.	OCT-22
H2141		NVO. STRADA 21/.. DEL.	MAY-24	H248484E		DUNA ELBA FIORINO PREMIO UNO // H-H 10x1 TRAS.	MAY-24
H2230		TORO 07/19 DOBLO 07/.. VER DEL.	OCT-22	H2231		TORO 07/19 DOBLO 07/.. VER TRAS.	OCT-22
<b>FORD</b>							
H3123		F4000 (F/D) TRAS/DER.	OCT-22	H3124		F4000 (F/D) TRAS/IZQ.	OCT-22
H3192		MONDEO III 00/07 DEL.	OCT-22	H3184		RANGER (DOBLE CONEXIÓN) 11/.. TRAS.	OCT-22
H3198		TRANSIT 11/.. DEL.	MAY-24	H3220		F600 SERIE 6000 F700 SERIE 7000 F800 - F850 SERIE 8000 83/98 DEL.	MAY-24
<b>HYUNDAI</b>							
H4814		H1 07/15 DEL/DER	MAY-24	H4815		H1 07/15 DEL/IZQ	MAY-24
H4623		MANGUERA DEPRESOR H100 94/16 - GALLOPER 2.5 DIESEL 91/03 - K2500	MAY-24	H4569		ELANTRA 01/06 TIBURON 03/08 TRAS	MAY-24
H4579		ELANTRA 97/06 F/T ACCENT 95/99 F/T VER TRAS	MAY-24	H4811		HB20 11/17 TRAS	MAY-24
H4819		CRETA 15/20 TRAS	MAY-24				
<b>IVECO</b>							
H2119		DAILY 08/.. DEL	MAY-24	H2120		DAILY II 90/99 TRAS	MAY-24
<b>JEEP</b>							
H9128		GRAND CHEROKEE T/D 99/04	MAY-24				



# LISTA DE NOVEDADES

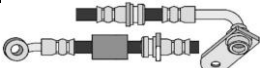





Código	Imagen	Descripción	Incorp.	Código	Imagen	Descripción	Incorp.
<b>JEEP - cont.</b>							
H9138	 440mm	RENEGADE 16/.. DEL.	OCT-22	H9140	 385mm	RENEGADE 16/.. TRAS.	OCT-22
<b>KIA</b>							
H8310	 525mm	BESTA GS 2.7L 00/06 DEL	MAY-24	H4622	 320mm	BESTA 2.2L 92/03 - K2500 2.5L 01/04 - K2700 2.7L 93/05 VER DEL	MAY-24
H4816	 410mm	SORENTO II 09/15 DEL/DER	MAY-24	H4817	 410mm	SORENTO II 09/15 DEL/IZQ	MAY-24
H4624	 500mm	SPORTAGE 95/02 DEL/DER	MAY-24	H4626	 500mm	SPORTAGE 95/02 DEL/IZQ	MAY-24
<b>MERCEDES BENZ</b>							
H5054	 550mm	SPRINTER MACHO LARGO 38mm 08/.. DEL/TRAS	MAY-24	H5056	 260mm	SPRINTER 95/06 TRAS	MAY-24
<b>NISSAN</b>							
H5846	 440mm	FRONTIER 18/.. DEL.	OCT-22				
<b>RASTROJERO</b>							
H89999E		ULTIMA SERIE INDENOR - PUNTERA HEMBRA D/T	MAY-24				
<b>RENAULT</b>							
H5850	 430mm	ALASKAN 17/.. DEL/DER	MAY-24	H5851	 430mm	ALASKAN 17/.. DEL/IZQ.	MAY-24
H5852	 420mm	ALASKAN 17/.. TRAS	MAY-24	H8273	 305mm	LOGAN II TRAS.	OCT-22
<b>ROVER - LAND ROVER</b>							
H6098	 720mm	ROVER 618 i/Si - 620 Sdi - 620 Si - 620 Ti VITESSE - 623 Si 93/99 DEL/DER	MAY-24	H6099	 720mm	ROVER 618 i/Si - 620 Sdi - 620 Si - 620 Ti VITESSE - 623 Si 93/99 DEL/IZQ	MAY-24
H6080	 440mm	LAND ROVER SANTANA D/T					
<b>SUZUKI</b>							
H7852	 775mm	VITARA - GRAND VITARA 98/15 DEL/DER	MAY-24	H7854	 775mm	VITARA - GRAND VITARA 98/15 DEL/IZQ.	MAY-24





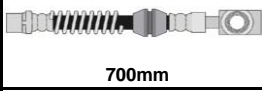
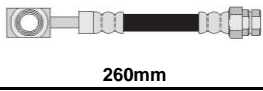
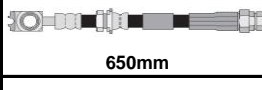
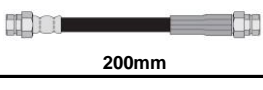

# LISTA DE NOVEDADES

Código	Imagen	Descripción	Incorp.	Código	Imagen	Descripción	Incorp.
<b>SUZUKI - cont.</b>							
H7826	 300mm	SAMURAI 1.3 - 1.9 85/04 DEL.	OCT-22				
<b>TOYOTA</b>							
H17118	 400mm	HIACE III 89/95 DEL/DER	MAY-24	H17119	 400mm	HIACE III 89/95 DEL/IZQ.	MAY-24
				H17087	 420mm	STOUT 2.0 RK110 (Doble Cab & 1,5 Ton) 84/86 - STOUT 2.2 YK110 (Doble Cab & 1,5 Ton) 87.. TRAS	MAY-24
<b>VOLKSWAGEN</b>							
H7094	 700mm	AMAROK V6 - AMAROK 3.0 TDI, 3.0 TDI 4 MOTION (OJAL 10mm) 16/22 DEL.	MAY-24	H7079/1	 260mm	BORA (OJAL 10mm) TRAS.	MAY-24
H7080	 650mm	T-CROSS 17/.. DEL.	OCT-22	H7088	 200mm	T-CROSS 17/.. TRAS.	OCT-22
H7020	 415mm	VARIANT II 77/.. DEL.	MAY-24	H7084	 430mm	TOUAREG 03/18 TRAS.	MAY-24



## CABLES DE FRENO, EMBRAGUE Y SELECTORA

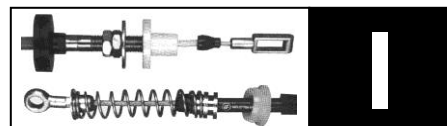

Código	Aplicación	Largo	Nº OEM	Incorp
i268	CAMBIO DE VELOCIDADES AUTOMATICO FORD TAUNUS	1300	78BR7A482A	AG-22
i661	EMBRAGUE FIAT 132 ARGENTA todos - Diesel Bosch 81/..	1130	4380878	ABR-24
i790	EMBRAGUE GM/CHEVROLET/OPEL SUPREMA 2.0 - 2.2 MPFI 4 CIL. 92/98 - SENATOR 88/93	1226	90335385 - 669159	AG-22
i902	EMBRAGUE MANGO HEX. C/2 TUERCAS P-504			ENE-23
i3015	EMBRAGUE FIAT MAREA MOTOR 1.9 TD 95/02	1510	46448106 - 46797595	ENE-24
i3565	EMBRAGUE VW 1600 / SAFARI REFORZADO / KARMAN GHIA Ghia 72/..	2290	111721335C	JUN-22
i3632	FRENO TRAS/D-I VW 1300 - 1500 - 1600 81/86	1770	1136097211 - 113609721L	JUN-22
i3676	EMBRAGUE VW BRAZILIA - REFORZADO	2345	adaptación 311721335A - 3117213351	JUN-22
i3694	EMBRAGUE RENAULT 5 MIRAGE			ENE-23
i3980	EMBRAGUE CON 2 CONTRAPESOS RENAULT 21 - NEVADA - RX - TXE - MEDALLON - ETOILE 87/..	1230	7700763190	AG-22
i4016	CAMBIO DE VELOCIDADES M. BENZ OMNIBUS 1725	10250	A3822600351	AG-22



# LISTA DE NOVEDADES

Código	Aplicación	Largo	Nº OEM	Incorp
i4019	CAMBIO DE VELOCIDADES M. BENZ OMNIBUS O500 RS	11000	A6292682891	AG-22
i4055	EMBRAGUE DAEWOO MATIZ 1.0 4V 05/..	835	96590793 - 25187023	AG-22
i4056	EMBRAGUE NISSAN TSURU III 1.6L 03/16	800	30770F4203	AG-22
i4488	EMBRAGUE GM/CHEVROLET/OPEL PICK-UP A10 - A20 - C10 - C20 85/88	730	94647409	AG-22
i4489	EMBRAGUE GM/CHEVROLET/OPEL CAMIÓN D40 85/88	725	94647410	AG-22
i4491	FRENO TRASERO GM/CHEVROLET/OPEL A10 - A20 - C10 - C20 - D10 - D20 85/88	1240	94637224	AG-22
i4495	FRENO DELANTERO FORD F4000 MOTOR MWM ASPIRADO 92/98	2185	T72609701	AG-22
i4539	EMBRAGUE GM/CHEVROLET/OPEL CHEVETTE 74/76	1190	9302835	AG-22
i4540	FRENO DELANTERO GM/CHEVROLET/OPEL A40 - C40 - D40 85/92	1490	94629727	AG-22
i4544	EMBRAGUE GM/CHEVROLET/OPEL PICK-UP A10 - C10 - D10 MOTOR 4 CILINDROS 79/84 - A14C y C14C 85/89	800	94602860	AG-22
i4578	FRENO TRASERO DERECHO/IZQUIERDO A CAMPANA VW POLO HATCH-SEDAN (BRASIL) 02/15	1660	6Q0609721K - 6Q0609721F	AG-22
i4635	CAMBIO DE VELOC. INSERCIÓN FIAT NUEVO PALIO (326) 1.4 MPI FIRE 8V (CAJA C514) ATTRACTIVE 17/..	1100	55261463	AG-22
i4636	CAMBIO DE VELOC. SELECCIÓN FIAT NUEVO PALIO (326) 1.4 MPI FIRE 8V (CAJA C514) ATTRACTIVE 17/..	1185	55261464	AG-22
i4654	CAMBIO DE VELOCIDADES CITROEN NUEVA JUMPER 05/17 // FIAT NUEVA DUCATO 05/18 // PEUGEOT NUEVA BOXER 05/17 // 2 CABLES UNIDOS CON GOMA	1038	71729169 - 2444V9 - 2444EC	AG-22
i4660	FRENO DELANTERO A CAMPANA CHEVROLET ONIX - PRISMA 13/..	190	52026809	AG-22
i4661	FRENO DEL. A CAMPANA CHEVROLET SPIN 12/..	230	52046580 - 52034393	AG-22
i4663	CAMBIO DE VELOCIDADES INSERCIÓN FIAT UNO II 1.4 MPI FIRE 10/.. -RÓTULA GRANDE- (EXT. PLÁSTICOS)	1095	55222272 - 68198829AA	AG-22
i4664	CAMBIO DE VELOCIDADES SELECCIÓN FIAT UNO II 1.4 MPI FIRE 10/.. -RÓTULA CHICA- (EXT. PLÁSTICOS)	1000	55222273 - 68198830AA	AG-22
i4670	CAMBIO DE VELOCIDADES TOYOTA YARIS 1.5 VVTI 16V 6 VELOC. 18/.. -2 CABLES UNIDOS POR GOMA-	1080	338200D760	AG-22
i4671	CAMBIO DE VELOC. CHEVROLET ONIX - PRISMA CAJA DE 5 VELOC. 20/.. -2 CABLES UNIDOS POR GOMA-	1085	24590069 - 24590218	AG-22
i4672	CAMBIO DE VELOCIDADES FORD FIESTA - COURIER 1.6L 16V 5 VELOC. 15/.. -2 CABLES CON GOMA UNIÓN-	1700	D2BZ7E395C	AG-22
i4689	CAMBIO DE VELOCIDADES VW NIVUS 1.0 T AT6 20/..	1400	2Q0713266M	AG-22
i4695	CAMBIO VELOC. FIAT DUCATO - TALENTO 2.3 16V TURBO DIESEL MULTIJET -2 CABLES UNIDOS CON GOMA- 19/..	1050	55284171 - K68403724AA	AG-22
i4712	BIELETA PEDAL DE EMBRAGUE PEUGEOT 206 - 207 - HOGGAR	-	212830	OCT-22
i4713	BIELETA PEDAL DE EMBRAGUE CITROEN BERLINGO // PEUGEOT PARTNER	-	212831	OCT-22
i4716	FRENO TRASERO EXTENSION A CAMPANA CHEVR. ONIX y PRISMA 13/.. - COBALT y SONIC 12/..	230	95492584 - 95231322	OCT-22
i4717	FRENO TRASERO EXTENSION A CAMPANA CHEVR. SPIN 12/.. - TRACKER y TRAX 13/..	235	95492583	OCT-22





# LISTA DE NOVEDADES

Código	Aplicación	Largo	Nº OEM	Incorp
i4719	FRENO TRASERO A DISCO FORD FOCUS III 13/.. - 2 CABLES CON CHAPA UNION	1970	AV612A603BL	OCT-22
i4721	CAMBIO DE VELOCIDADES (CAMBIO AT6) CAJA AUTOMATICA // CITROEN C4 CACTUS 1.2 T PURETECH - 1.6 16V 17/... - C-ELYSEE 1.6 16V 17/20 - DS3 1.2 T PURETECH 17/... // PEUGEOT 301 1.6 16V 17/18 - PEUGEOT 208 1.6 16V EC5 12/... - PEUGEOT2008 1.6 16V EC5 16/..	1320	9814628080	AG-22
i4729	CAMBIO VELOC. AUTOMÁT. FORD RANGER 12/..	1255	AB397E395AF	ENE-24
i4730	FRENO TRAS. A CAMPANA (SIN ABS) -2 CABLES CON CHAPA UNIÓN- FORD FOCUS II 08/13	2980	1707756 - 3M512A603EC	MAR-23
i4731	FRENO DE MANO TRASERO A DISCO FORD FOCUS II	3730	1707757 - 3M512A603FC	ENE-24
i4745	FRENO TRASERO DERECHO (SIN CHAPAS SOPORTE) NISSAN FRONTIER MWM 2.8 DTI 03/08	2270	365306S302	AG-22
i4746	FRENO TRASERO IZQUIERDO NISSAN FRONTIER MWM 2.8 DTI 03/08	1095	365316S302	AG-22
i4749	FRENO DELANTERO NISSAN FRONTIER MWM 2.8 DTI 03/08	2215	364028Z311	ENE-24
i4750	FRENO TRASERO DERECHO NISSAN FRONTIER 2.3 DCI 16/18	2175	365304KH0B	ENE-24
i4751	FRENO TRASERO IZQUIERDO NISSAN FRONTIER 2.3 DCI 16/18	2440	365314KH0B	ENE-24
i4752	BIELETA PASAJE DE CAMBIOS PEUGEOT 207 - HOGGAR (CAJA MA) CHASIS 1148077/..	80	2454G8	ENE-24
i4753	BIELETA PASAJE DE CAMBIOS CITROEN XSARA - XSARA PICASSO	90	245286	ENE-24
i4754	BIELETA SELECCIÓN DE CAMBIOS CITROEN BERLINGO // PEUGEOT PARTNER // (CAJA BE4R)	115	2454F5	ENE-24
i4755	BIELETA SELECCIÓN DE CAMBIOS PEUGEOT 206 - 207 - HOGGAR (CAJA BE4R)	120	2454G4	ENE-24
i4756	BIELETA SELECCIÓN DE CAMBIOS PEUGEOT 206- 207 - HOGGAR (CAJA MA)	160	2454G5	ENE-24
i4757	BIELETA PASAJE DE CAMBIOS CITROEN BERLINGO // PEUGEOT PARTNER - 206 - 207 - HOGGAR // (CAJA BE4R)	280	245281	ENE-24
i4758	EMBRAGUE REGULACION AUTOMATICA C/CONTRAPESO CITROEN BERLINGO 1.4 N (75 CV) - 1.6 16v (110 CV) - 1.6 HDI (90 CV) 10/16 // PEUGEOT PARTNER 1.4 N (75 CV) - 1.6 16v (110 CV) - 1.6 HDI (90 CV) 10/16	880	9825669080	AG-22
i4759	EMBRAGUE REGULACION MANUAL SIN CONTRAPESO CITROEN BERLINGO1.4 N (75 CV) - 1.6 16v (110 CV) - 1.6 HDI (90 CV) 10/16 // PEUGEOT PARTNER 1.4 N (75 CV) - 1.6 16v (110 CV) - 1.6 HDI (90 CV) 10/16	940	ADAPT. 9825669080 - 9837204380	ENE-23
i4766	BIELETA PEDAL DE EMBRAGUE CITROEN BERLINGO // PEUGEOT 306 - PARTNER	-	212822	ENE-23
i4768	FRENO TRAS/DER. A CAMPANA FIAT PULSE 1.3 DRIVE - 1.0T IMPETUS 22/..	1620	52156077	ENE-23
i4769	FRENO TRAS/IZQ. A CAMPANA FIAT PULSE 1.3 DRIVE - 1.0T IMPETUS 22/..	1650	52156078	ENE-23
i4770	FRENO TRAS/DER-IZQ. A DISCO VW VENTO 11/18	1625	5C0609721BC	ENE-23
i4771	FRENO DEL. A CAMPANA CHEVROLET SONIC 12/.. - COBALT 13/..	185	95229769 - 95937512	ENE-23





# LISTA DE NOVEDADES

Código	Aplicación	Largo	Nº OEM	Incorp
i4772	FRENO DEL. TOYOTA COROLLA 08/14	320	4641002160 - 4641002170	ENE-23
i4776	CAMBIO VELOCIDADES FIAT PULSE IMPETUS 1.0 - 1.3 DRIVE 1.3	1215	52150088	ENE-24
i4777	FRENO DELANTERO NISSAN FRONTIER 2.3 DCI 18/.. // RENAULT ALASKAN 2.3 DCI 20/..	555	364024KD0B	ENE-24
i4778	FRENO TRASERO DERECHO NISSAN FRONTIER 2.3 DCI 18/.. // RENAULT ALASKAN 2.3 DCI 20/..	2180	365305JL0A	ENE-24
i4779	FRENO TRASERO IZQUIERDO NISSAN FRONTIER 2.3 DCI 18/.. // RENAULT ALASKAN 2.3 DCI 20/..	2490	365315JL0A	ENE-24
i4781	FRENO TRASERO DERECHO NISSAN VERSA MOTOR 1.6 (107 CV) 13/20	1835	365303BA0A	ENE-24
i4782	FRENO TRASERO IZQUIERDO NISSAN VERSA MOTOR 1.6 (107 CV) 13/20	1825	365313BA0A	ENE-24
i4785	FRENO TRASERO DER/IZQ A CAMPANA 14/.. RENAULT LOGAN - SANDERO	1730	365306778R	MAY-23



## DEPOSITOS PARA LIQUIDO DE FRENOS



Código	Imagen	Descripción	Incorp.
K4032		DEP. LIQUIDO FRENO SIN TAPA CHEVROLET CORSA	ABR-24

Código	Imagen	Descripción	Incorp.



## CAÑOS DE COBRE Y CONEX. DE BRONCE



Cód.	Med.	Aplicación	Ilustración	Incorp.
M10107	-	DERIVADOR FORD RANGER 10x1 CON CONO (CHAPA)		MAY-24
M10108	-	DERIVADOR FORD RANGER 10x1 CON CONO (BLOQUE)		MAY-24



# LISTA DE NOVEDADES



## DISCOS Y CAMPANAS



### DISCOS DE FRENO

Cód.	Aplicación	Año	D T	S V	A mm	B mm	C mm	D mm	D Min. mm	E	Incorp.
N4118	TOYOTA HILUX 2.8TDI AT - SW4 2.8TDI AT	20/..	D	V	319,0	67,5	108,0	38,0	25,0	6+2	ABR-24



# LISTA DE NOVEDADES



## CHAJA

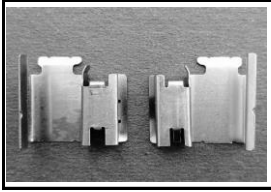

P1584

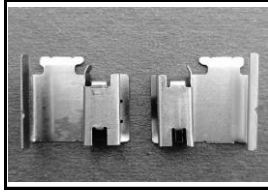

P1585



P1608



P1609



P1610



P1611



P1625



P1626

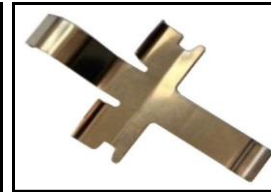

P1630



P1633



P2228A

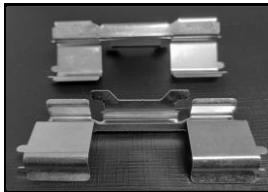

P2230A



P2233A



P2284A

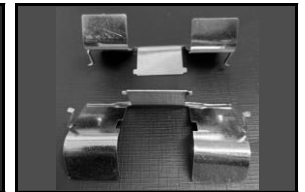

P2285A



P2520T



P2521T



P2522T



P2523T

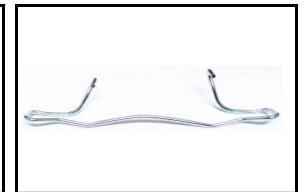

P2650

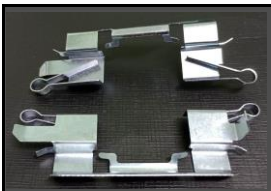

P7203



P9107



P9108



P9109



P9110



P9111



P9112



P22230



P22598

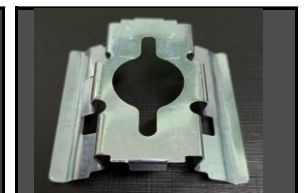

P42337

Código	Marca	Aplicación	Incorp
P1584	CITR. - PEUG. - VW	ANTIRRUIDO DER/IZQ.- CITR. C4 VTS - C4 // PEUG. P307 // VW AMAROK - BOSCH NVA. APLICACIÓN	SEP-23
P1585	CITR. - PEUG. - VW	ANTIRRUIDO DER/IZQ.- CITR. C4 VTS - C4 // PEUG. P307 // VW AMAROK - BOSCH - NVA. APLICACIÓN	SEP-23
P1608	TOYOTA	JGO. LEVA IZQUIERDA TOYOTA HILUX 05/..	FEB-23



# LISTA DE NOVEDADES

Código	Marca	Aplicación	Incorp
P1609	TOYOTA	JGO. LEVA DERECHA TOYOTA HILUX 05/..	FEB-23
P1610	IVECO	JUEGO LEVA IVECO (TODOS)	MAR-23
P1611	CITR. - FIAT - PEUG.	JGO. LEVA CITROEN JUMPER - FIAT DUCATO - PEUGEOT BOXER 01/17	SEP-23
P1625	CHEVROLET	REGISTRO IZQUIERDO CHEVROLET ASTRA - CORSA II - MERIVA	FEB-23
P1626	CHEVROLET	REGISTRO DERECHO CHEVROLET ASTRA - CORSA II - MERIVA	FEB-23
P1630	TOYOTA	ANTIRRUIDO DE CALIPER DEL. DER/IZQ. TOYOTA HILUX - ACERO	MAY-24
P1633	FORD	PERNO PARA GATILLO FORD RANGER	SEP-23
P2228A	CHEVROLET	KIT ANTIRRUIDO CHEVROLET S10 4x2 - 4x4 12/16	MAY-24
P2230A	IVECO	KIT ANTIRRUIDO PAST. IVECO 70C16, 70C17, 35S14 ECONOLINE CD	MAY-24
P2233A	HYUNDAI	KIT ANTIRRUIDO PAST. HYUNDAI HR DEL.	MAY-24
P2284A	KIA	KIT ANTIRRUIDO CALIPER KIA BONGO, K2700, K2500 ../12, K2400 ../00	MAY-24
P2285A	FIAT	KIT ANTIRRUIDO CALIPER FIAT DUCATO 16" C/ABS	MAY-24
P2520T	FORD	TUERCA FORD FOCUS RCA. 10x1,5 - LARGO 17,5mm	MAY-24
P2521T	FORD	TUERCA FORD FOCUS RCA. 12x1,5 - P/CAÑO 3/16" - LARGO 17,5mm	MAY-24
P2522T	FORD	TUERCA FORD FOCUS RCA. 12x1,5 - P/CAÑO 1/4" - LARGO 17,5mm	MAY-24
P2523T	FORD - TOYOTA	TUERCA FORD RANGER - TOYOTA RCA. 10x1 - LARGO 16mm	MAY-24
P2650	VW	TRABA PASTILLA VW BORA - GOL - PASSAT - VENTO	ENE-23
P7203	MITSUBISHI	KIT ANTIRRUIDO DEL. MITSUBISHI L200, TRITON 12/20	MAY-24
P9107	FIAT - FORD	REGULADOR IZQUIERDO FIAT QUBO - FORD ECOSPORT	MAR-23
P9108	FIAT - FORD	REGULADOR DERECHO FIAT QUBO - FORD ECOSPORT	MAR-23
P9109	IVECO	REGISTRO IVECO 60.13 - 70.13V 8.5TN	MAR-23
P9110	FIAT	REGISTRO FIAT DUCATO R15/16 (TODOS)	MAR-23
P9111	MITSUBISHI	REGISTRO DERECHO MITSUBISHI MONTERO 89/95	MAR-23
P9112	MITSUBISHI	REGISTRO IZQUIERDO MITSUBISHI MONTERO 89/95	MAR-23
P22230	FIAT - JEEP	KIT ANTIRRUIDO DEL. FIAT TORO - JEEP RENEGADE, COMPASS 16/21	MAY-24
P22598	VW	KIT ANTIRRUIDO VW BORA, GOLF, NEW BEETLE, PASSAT, VENTO, ETC.	MAY-24
P42337	CITROEN - FIAT - PEUGEOT - TOYOTA	ANTIRRUIDO CALIPER TRASERO CITROEN JUMPER - FIAT DUCATO - PEUGEOT BOXER - TOYOTA JARIS	MAY-24



# LISTA DE NOVEDADES



## CILINDROS DE FRENO

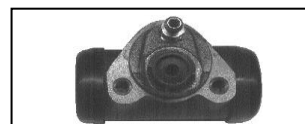

# Q

Cód.	Aplicación	Año	Med	Sist.	Ubic.	Imagen	Inc.
Q454	CIL. RDA. FORD FOCUS III	07/14	13/16"	-	TRAS		ABR-23
Q9901L	CIL. RDA. LPR 4913 VOLKSWAGEN CARAT - GACEL - GOL - PASSAT - SANTANA - SENDA	-	9/16"	VARGA	TRAS		JUN-24
Q9905	CIL. RDA. FIAT DOBLO - 500 // VW POLO - T-CROSS	17/..	13/16"	-	TRAS		ABR-23
Q9906	CIL. RDA. VW NVO POLO RCA: 10x1	18/..	3/4"	-	TRAS		ABR-23
Q10111	CIL. RDA. NISSAN FRONTIER RCA: 10x1 C/CONO	-	1"	-	TRAS		ABR-23
Q10112	CIL. RDA. NISSAN SENTRA	-	5/8"	-	TRAS		ABR-23
Q10113	CIL. RDA. NISSAN KICKS - VERSA RCA: 10x1 C/CONO	16/23	3/4"	-	T/IZQ		NOV-23
Q10114	CIL. RDA. NISSAN KICKS - VERSA RCA: 10x1 C/CONO	16/23	3/4"	-	T/DER		NOV-23
Q18002	CIL. RDA. HONDA CIVIC CRV - CRX	-	13/16"	-	T/IZQ		JUN-23





# LISTA DE NOVEDADES

Cód.	Aplicación	Año	Med	Sist.	Ubic.	Imagen	Inc.
Q18003	CIL. RDA. HONDA CIVIC CRV - CRX	-	13/16"	-	T/DER		JUN-23
Q18004	CIL. RDA. HONDA CIVIC CRV - CRX	-	3/4"	-	T/IZQ		JUN-23
Q18005	CIL. RDA. HONDA CIVIC CRV - CRX	-	3/4"	-	T/DER		JUN-23
Q18006	CIL. RDA. HONDA CITY - FIT	-	3/4"	-	TRAS		JUL-23
Q31201	VÁLV. LIMITADORA NISSAN VERSA - TIIDA	-	-	-	-		ABR-24
Q84301L	CIL. RDA. LPR 4248 - CHEVROLET ASTRA - CORSA - VECTRA	-	3/4"	VARGA	TRAS		JUN-24
Q85401L	CIL. RDA. LPR 4876 CITROEN BERLINGO // PEUGEOT PARTNER	-	7/8"	LUCAS	TRAS		JUN-24
Q85810	CIL. RDA. RENAULT KWID	17/..	5/8"	-	TRAS		ABR-23
Q85811	CIL. RDA. RENAULT ALASKAN 2.3 DCI 4x4	-	7/8"	-	TRAS		ABR-24





# LISTA DE NOVEDADES



**BBAS. EMBRAGUE, FRENO Y CIL.  
AUX. NACIONAL - IMPORTADO**



**QB  
QR  
QS**

Cód.	Aplicación	Año	Med	Sist.	Tipo	Imagen	Inc.
QB039	CRAPODINA HIDRAULICA DE EMBRAGUE MERCEDES BENZ 712 - 914 - 1215 - 1620 - ATEGO - AXOR	VER	23mm				DIC-22
QB040	CRAP. HIDR. EMBR. FORD KUGA 2.5T 09/14 - MONDEO 2.5T 07/14 // LAND ROVER FREELANDER II 2.2 DIESEL 06/..	VER	Ø 31mm				SEP-22
QB041	CRAPODINA HIDRAULICA DE EMBRAGUE (PLÁSTICO) CHEVROLET CRUZE 1.4T	16/..	Ø 27mm				SEP-22
QB042	CRAP. HIDR. EMBR. CITROEN C4 GRAND PICASSO 1.6 THP, 1.6 HDI - C4 LOUNGE 1.6 THP, 1.6 HDI 13/.. - DS3 1.6 THP - DS4 1.6 THP // PEUGEOT 208 1.6 THP - 308 1.6 THP, 1.6 HDI - 408 1.6 THP, 1.6 HDI - 2008 1.6 THP - 3008 1.6 THP	VER	Ø 24mm				SEP-22
QB043	CRAP. HIDR. EMBR. CITROEN C4 GRAND PICASSO 1.6 THP, 1.6 HDI - C4 LOUNGE 1.6 THP, 1.6 HDI 13/.. - DS3 1.6 THP - DS4 1.6 THP // PEUGEOT 208 1.6 THP - 308 1.6 THP, 1.6 HDI - 408 1.6 THP, 1.6 HDI - 2008 1.6 THP - 3008 1.6 THP	VER	Ø 23mm				SEP-22
QB044	CRAPODINA HIDRAULICA DE EMBRAGUE TOYOTA COROLLA 09/.. - ETIOS 16/..	VER	Ø 28mm				SEP-22
QB046	CRAPODINA HIDRAULICA DE EMBRAGUE (CAÑO LARGO) NISSAN TIIDA 08/.. - X-TRAIL 11/.. // RENAULT DUSTER 11/.. - FLUENCE 10/.. - KOLEOS 09/.. - MEGANE III 11/..	VER	5/8"				AG-22
	<b>CONEXIÓN: ENCHUFAR</b>						
QB055	CRAPODINA HIDRAULICA DE EMBRAGUE FIAT TORO 16/.. - TORO 2.0 // JEEP COMPASS 17/.. - RENEGADE 16/..	VER	23mm				DIC-22





# LISTA DE NOVEDADES

Cód.	Aplicación	Año	Med	Sist.	Tipo	Imagen	Inc.
QB3110	BOMBA DE EMBRAGUE HYUNDAI TUCSON // KIA SPORTAGE	10/..	5/8"				SEP-22
QB10250	BOMBA DE EMBRAGUE TOYOTA COROLLA 09/.. - ETIOS 12/..	VER	5/8"				SEP-22
QB12300	BBA. EMBRAGUE NISSAN SENTRA 13/16 - TIIDA 07/15 - VERSA 13/15	VER	5/8"				JUL-23
QB12301	BBA. EMBRAGUE NISSAN MARCH 12/.. - NOTE 15/.. - VERSA 15/20	VER	5/8"				JUL-23
QB13610	BBA. EMBRAGUE (CAJA AUTOMÁTICA EASYTRONIC) CHEVR. CORSA II - MERIVA	03/..					SEP-22
QB13611	BBA. EMBRAGUE CHEVROLET CRUZE 1.4 TURBO	16/..	5/8"				SEP-23
	<i>CONEXIÓN: ENCHUFAR</i>						
QB15605	BOMBA DE EMBRAGUE FORD ECOSPORT 12/17 - ECOSPORT 17/.. - FIESTA KINETIC 10/..	VER	5/8"				SEP-22
	<i>CONEXIÓN: ENCHUFAR</i>						
QB17103	BBA. EMBRAGUE SUZUKI SWIFT	08/..	5/8"				AG-22
	<i>CONEXIÓN: ENCHUFAR</i>						
QB17104	CILINDRO AUXILIAR DE EMBRAGUE SUZUKI SWIFT	08/..	13/16"				AG-22
	<i>CONEXIÓN: ENCHUFAR</i>						
QB17203	BBA. EMBRAGUE SUZUKI GRAND VITARA JIII	08/..	5/8"				AG-22
	<i>CONEXIÓN: ENCHUFAR</i>						





# LISTA DE NOVEDADES

Cód.	Aplicación	Año	Med	Sist.	Tipo	Imagen	Inc.
QB19100	BBA. EMBRAGUE DODGE JOURNEY 08/.. // JEEP COMPASS 06/.. - PATRIOT 07/..	VER	11/16"				AG-22
	CONEXIÓN: ENCHUFAR						
QB23503	BBA. FRENO C/DEPOSITO VW GOL TREND SAVEIRO TREND MOTOR MSI	14/..	7/8"	DC			SEP-23
	CONEXIÓN 2 - 10x1 // 2 - 12x1						
QB24108	BOMBA DE EMBRAGUE NISSAN XTRAIL 08/14 // RENAULT KOLEOS 09/15	VER	5/8"				SEP-22
	CONEXIÓN: ENCHUFAR						
QB24109	BOMBA DE EMBRAGUE RENAULT DUSTER - DUSTER OROCH	-	5/8"				SEP-22
	CONEXIÓN: ENCHUFAR						
QB24110	BBA. EMBRAGUE RENAULT LOGAN 13/.. - SANDERO 15/.. - STEPWAY 15/..	VER	5/8"				AG-22
	CONEXIÓN: ENCHUFAR						
QB24111	BBA. EMBRAGUE RENAULT FLUENCE - MEGANE II		5/8"				ENE-24
	CONEXIÓN: ENCHUFAR						
QB25104	BBA. EMBRAGUE FIAT TORO // JEEP RENEGADE		5/8"				JUL-23
	CONEXIÓN: ENCHUFAR						
QB25105	BBA. EMBRAGUE FIAT LINEA - PUNTO	08/..	5/8"				AG-22
	CONEXIÓN: ENCHUFAR						
QB25106	BOMBA DE EMBRAGUE FIAT ARGO - CRONOS - GRAND SIENA - PALIO NOVO - UNO FASE II 10/..	-	5/8"				SEP-22
	CONEXIÓN: ENCHUFAR						
QB29101	BOMBA DE EMBRAGUE CITROEN C4 // PEUGEOT 307 - 308	-	5/8"				SEP-22
	CONEXIÓN: ENCHUFAR						



# LISTA DE NOVEDADES

Cód.	Aplicación	Año	Med	Sist.	Tipo	Imagen	Inc.
QB32101	BOMBA DE EMBRAGUE (ALUMINIO) CHERY TIGGO 1.6	08/16	5/8"				SEP-22
QB32102	BBA. EMBRAGUE (ALUMINIO + PLÁSTICO) CHERY TIGGO 2.0	08/16	3/4"				SEP-22
QB32103	CILINDRO AUXILIAR DE EMBRAGUE CHERY TIGGO  CONEXIÓN: M10x1	08/13	13/16"				SEP-22
QR4207	BBA. EMBR. FORD CARGO	11/..	1"				ABR-23
QR4407	CIL. AUX. EMBR. FORD CARGO	-	1 1/8"				ABR-23
QS2003	BBA. FRENO DC TOYOTA HILUX - SW4 2.4 - 2.8  2 SAL.: 12x1 C/CONO	15/..	7/8"				NOV-23
QS06268	BBA. FRENO FORD RANGER 2.2TDCI - 2.5N - 3.2TDCI 4x2 - 4x4 MT  2 SAL.: 10x1	12/16	7/8"				ENE-24
QS06269	BBA. FRENO FORD RANGER 2.2TDCI - 2.5N - 3.2TDCI 4x2 - 4x4 MT  2 SAL.: 12x1	12/16	7/8"				MAR-24
QS07120	BBA. FRENO DC CHEVROLET S10 2.8 LS/LT/LTZ (MANUAL)  2 SAL.: 10x1	12/17	7/8"	BOSCH			ABR-23
QS07121	BBA. FRENO DC CHEVROLET S10 2.8 LS/LT/LTZ (AUTOMÁTICO)  2 SAL.: 12x1	12/17	7/8"	BOSCH			ABR-23



# LISTA DE NOVEDADES

Cód.	Aplicación	Año	Med	Sist.	Tipo	Imagen	Inc.
QS13115	BBA FRENO M. BENZ VITO 111 - FURGON 119 - COMBI 121 - TOURER C/ABS 2 SAL.: 12x1	15/..	1 1/16"	TRW			SEP-23
QS16214	BBA. FRENO CITROEN BERLINGO - XSARA // PEUGEOT 306 - PARTNER // (todos c/ABS) 2 SAL.: 10x1 - 12x1	97/15	15/16"	ATE			MAY-22
QS18110	BBA. FRENO RENAULT CLIO II - KANGOO - KANGOO EXPRESS C/ABS 2 SAL.: 10x1 - 12x1	97/08	7/8"	BOSCH			JUN-22
QS18158	BBA. FRENO RENAULT KWID 2 SAL.: 10x1	17/..	3/4"	BOSCH			AG-23
QS18159	BBA. FRENO RENAULT MEGANE II - SCENIC II 2 SAL.: 12x1		15/16"	-			MAY-23
QS21230	BBA. FRENO VW AMAROK 2.0TDI (ALUMINIO - SIN DEPOSITO) 2 SAL.: 12x1	10/16	1 1/16"				ENE-24





# LISTA DE NOVEDADES

## (1254) RD12484M

CHEVROLET TRACKER 17/..

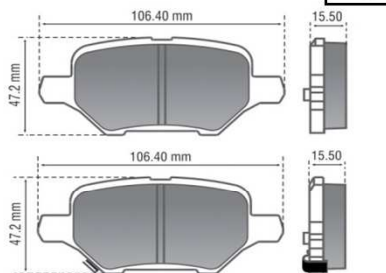

## (1079) RD12485M

AUDI Q5 08/.. - A4 08/12 - A5 08/12

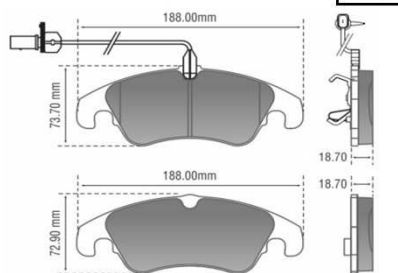

## (1236) RD12486

CHEVROLET ONIX 1.0 TURBO 19/..

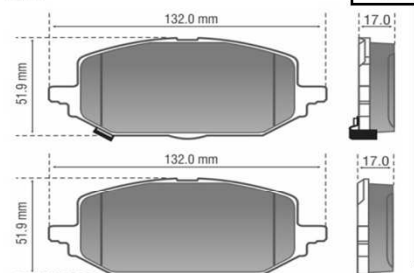

## (1175) RD12488

KIA PICANTO 11/..

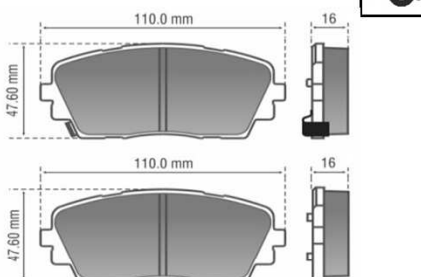

## (0916) RD12495M

CITROEN JUMPY II 1.6 + 2.0 HDI 07/.. - SPACE TOURER 06/.. // FIAT SCUDO II 1.6 - 2.0 07/.. // PEUGEOT EXPERT 06/.. - EXPERT II TEPEE 1.6 - 2.0 07/..

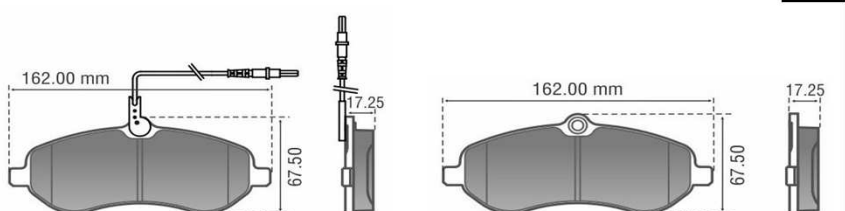

## (0899) RD12497M

HYUNDAI CRETA 1.6 - 2.0 ATTITUDE - PULSE - PRESTIGE 16/.. - I30 - I30 CW 1.4 - 1.6 - 2.0 07/.. // KIA CARENS II EX LX- CRDI 1.6 - 1.8 - 2.0 02/.. CERATO 1.6 - 2.0 EX FORTE 10/.. - SOUL II 1.6 - 2.0 CVVT 14/..

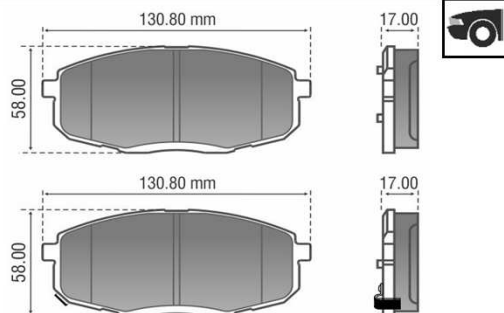

## RD12498M

MERCEDES BENZ ACTROS 1841 14/17 - ACTROS 2531 13/14 - ACTROS 2636 12/14 - ACTROS 1841 LS 15/.. - ACTROS 1846 LS 15/.. - ACTROS 2041 S 11/.. - ACTROS 2042 S 18/.. - ACTROS 2044 S 11/14 - ACTROS 2046 S 13/.. - ACTROS 2048 LS 18/.. - ACTROS 2051 LS 18/.. - ACTROS 2645 LS 19/.. - ACTROS 2646 LS 19/.. - ACTROS 2646 S/LS 11/17 - ACTROS 2655 LS 17/..

## RD12499M

MERCEDES BENZ ACTROS 1841 14/17 - ACTROS 2531 13/14 - ACTROS 2636 12/14 - ACTROS 1841 LS 15/.. - ACTROS 1846 LS 15/.. - ACTROS 2041 S 11/.. - ACTROS 2042 S 18/.. - ACTROS 2044 S 11/14 - ACTROS 2046 S 13/.. - ACTROS 2048 LS 18/.. - ACTROS 2051 LS 18/.. - ACTROS 2645 LS 19/.. - ACTROS 2646 LS 19/.. - ACTROS 2646 S/LS 11/17 - ACTROS 2655 LS 17/..

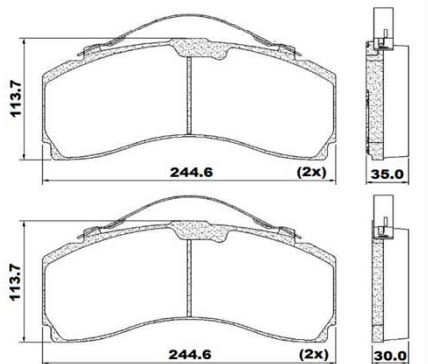
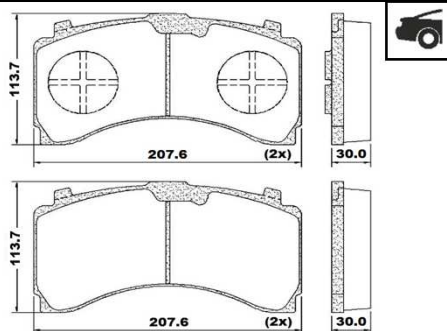

## (0520) RD12500M

IVECO EURO RIDER 99/.. // M. BENZ ACTROS 1938 98/.. // SCANIA K-124 - 230 - 270 - 310 - 340 - 380 4x2 08/.. - SERIE 4 R144 LB 99/.. - SERIE 4 T124 6B 99/.. // KNORR

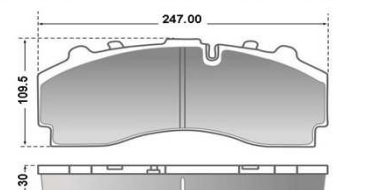

## (1071) RD12506M

AUDI A3 II - S3 1.4 TSI - 1.8 - 2.0 TDI 12/.. - Q2 TFSI 2.0 QUATTRO 16/.. // SEAT ALHAMBRA II 1.4 TSI - 2.0 TDI 16V 4WD 10/.. // VW GOLF VII 1.4 TSI - 2.0 GTI 18/.. - PASSAT CC 2.0 TSI - 3.6 TFSI 08/.. - SHARAN II 1.4 TSI - 2.0 TDI 16V 4WD 10/.. - TIGUAN II 1.4 TSI - 2.0 TDI 17/..

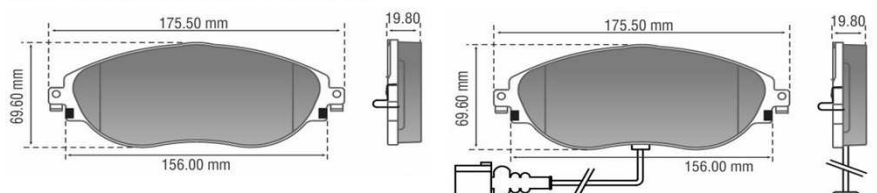



# LISTA DE NOVEDADES

## (1131) RD12511M

TOYOTA COROLLA 2.0 16V CVT 20/.. - 1.8 - HYBRID 20/..

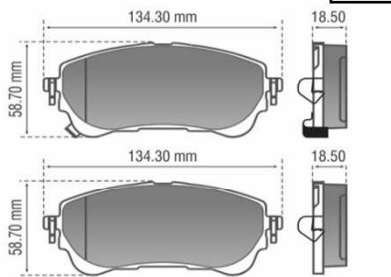

## (1250) RD12512M

TOYOTA COROLLA 2.0 16V CVT 20/.. - 1.8 - HYBRID 20/..

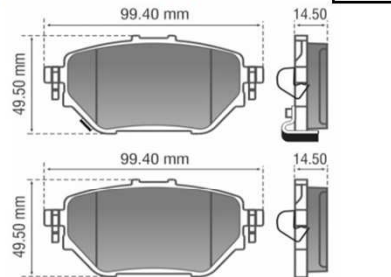

## RD12513M

CITROEN C4 VTR 05/.. // PEUGEOT 2008 1.6 15/..

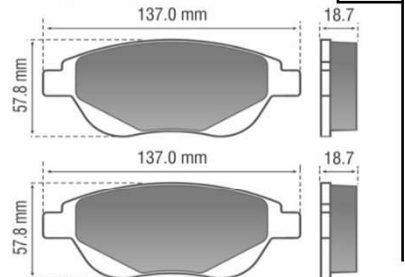

## (0989) RD12522M

FIAT ARGO 1.8 - CRONOS - LINEA - PALIO WEEKEND ADVENTURE - STRADA ADVENTURE

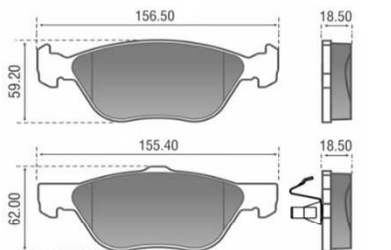

## (1080) RD12523M

AUDI A4 1.8 - 2.0 - 2.7 - 3.2 TDI - TFSI 16V 07/.. - A5 QUATTRO 2.0 - 2.7 - 3.0 - 3.2 TDI TFSI 09/.. - A6 QUATTRO 2.0 - 2.7 - 3.0 - 3.2 TDI TFSI 11/.. - A7 SPORTBACK 2.8 - 3.0 TDI - FSI 10/.. - Q5 QUATTRO 2.0 - 3.0 - 3.2 TDI TFSI 09/.. // TRW

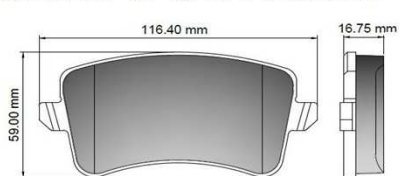

## RD12524M

BMW SERIE 3 99/08

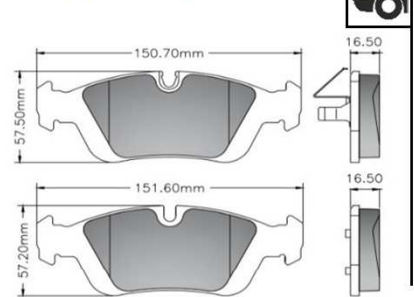

## RD12526M

BMW SERIE 3 99/08

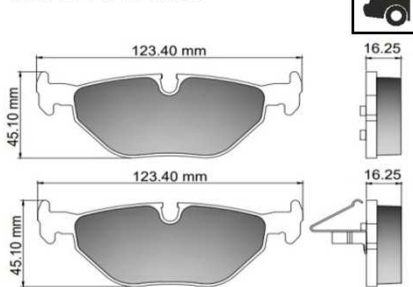

## (1149) RD12527M

CITROEN C4 GRAND PICASSO 1.2 - 1.6 - 2.0 HDI 13/.. - C4 PICASSO 1.2 - 1.6 - 2.0 HDI 13/.. // DS7 // PEUGEOT 3008 THP 1.6 - 2.0 HDI 14/.. - 309 II SW 1.2 - 1.6 - 2.0 HDI 14/.. - BOSCH

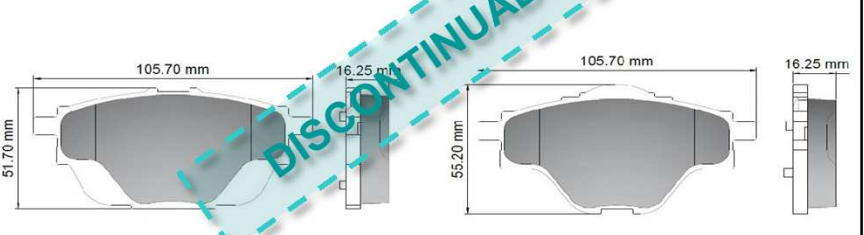

## (1206) RD12530M

AUDI A7 II SPORTBACK 10/17 // VOLKSWAGEN TOUAREG 11/17

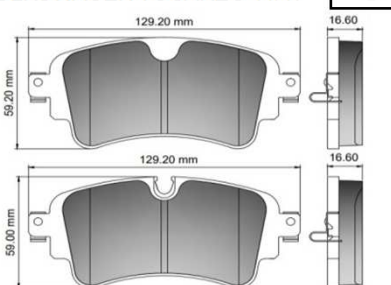

## RD12531M

CHEVROLET TRACKER 1.2 TURBO 20/..

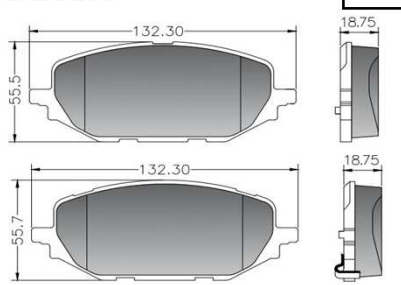

## RD12532M

BMW SERIE 1

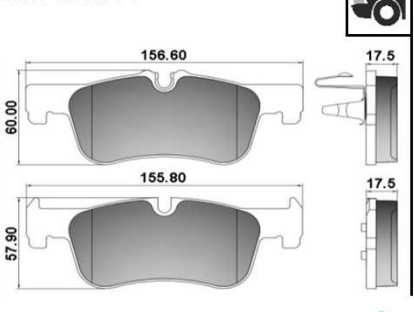

## RD12533M

CITROEN C4 PICASSO II - GRAND PICASSO II 1.6 16/.. - BERLINGO K-9 19/.. // PEUGEOT PARTNER K-9 19/..

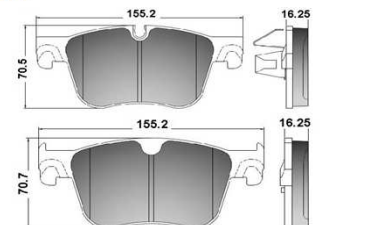

## (1246) RD12535M

M. BENZ SPRINTER III 215 - 216 - 217 - 311 - 315 - 317 - 411 - 414 - 416 CDI 18/.. - BREMBO

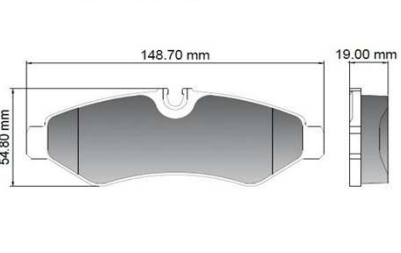

## (1260) RD12536M

MERCEDES BENZ SPRINTER 516 19/..







# LISTA DE NOVEDADES

## (0952) RD12537M

HONDA CITY - FIT - WR-V EX - EXL 1.5

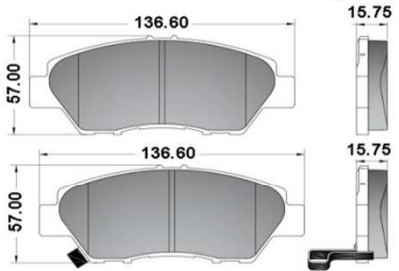

## RD12544M

BMW SERIE 3 (E90 - E91 - E92) 06/12 - X1 (E84) 10/14

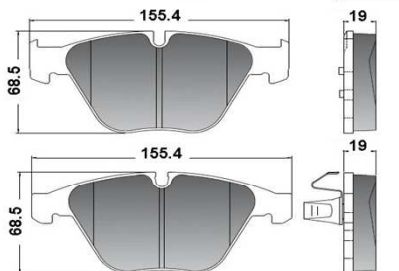

## RD12548M

CHEVROLET EQUINOX 1.5 18/.. LLANTA 17"

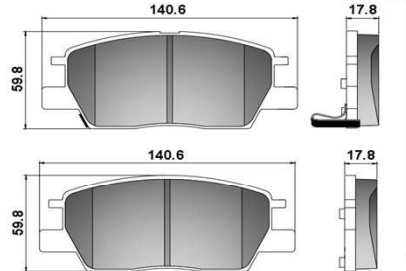

## RD12549M

CHEVROLET EQUINOX 1.5 TURBO 18/..

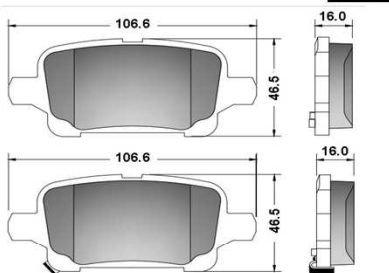

## RD12550M

CITROEN C4 - C5 - DS4 // PEUGEOT 308 - 508 - RCZ

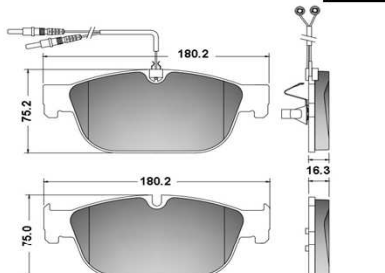

## RD12552M

BMW X1 15/.. - BMW 2 ACTIVE // MINI CLUBMAN

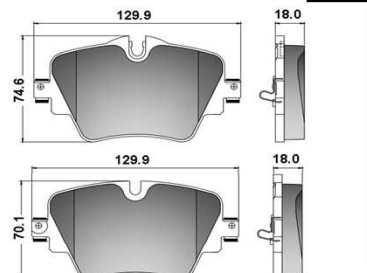

## RD12553M

BMW X1 15/.. - BMW 2 ACTIVE // MINI CLUBMAN

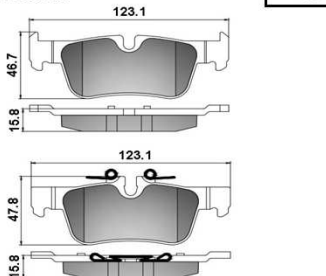

## RD12554M

CITROEN C4 - C4 PICASSO - BERLINGO // PEUGEOT 5008 - PARTNER // DS4

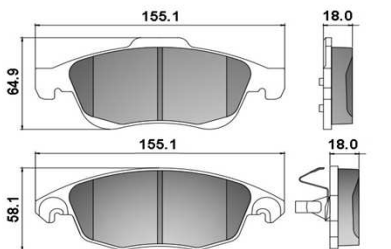

## RD12555

CITROEN C4 // PEUGEOT 207 - 207SW - 307

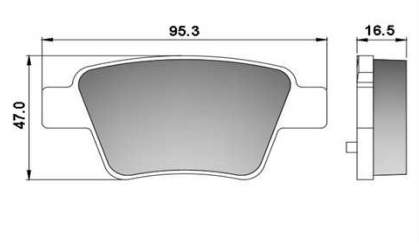

## (0979) RD12959AM

A. ROMEO 156 2.0 00/02 // FIAT LINEA 1.4, 1.8 08/.. - BRAVO 11/..

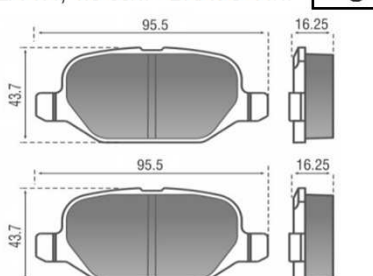

## (0852) RD12902AM

M. BENZ ACCELO 915-C 16/.. - ATEGO I 1017 a 1023 - 712 a 717 - 812 a 823 - 917 a 923 98/..

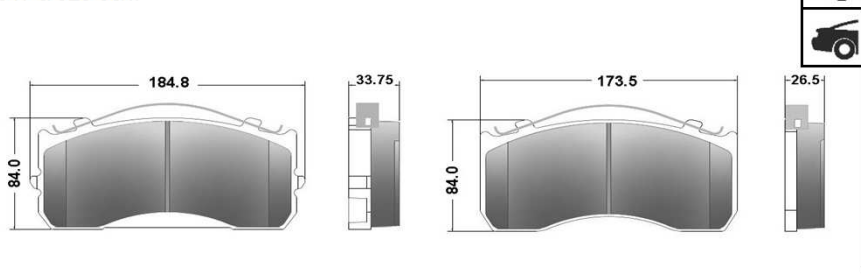

## (1219) RD12972M

MB SPRINTER 3.5 - 3T. - 4.6T. - 5T. - VITO NVA. APLIC.

