



LISTA DE NOVEDADES

INCOPORACIONES AL:



CATALOGO GENERAL



CATALOGO CHAJA



CATALOGO BOMBAS Y CILINDROS



CATALOGO PASTILLAS DE FRENO



Av. Mitre 1293 - (1878) Quilmes, Bs. As. - Rep. Argentina - WWW.ITALFREN.COM.AR - info@italfren.com.ar

(011) 7504-4545 / 4618 (Telecentro) - (011) 5057-8417 Whatsapp

Fax s/cargo 0800-222-2047



LISTA DE NOVEDADES



REPARACIONES DE FRENOS A DISCO



Cód.	Med.	Aplicación	Ilustración	Incorp.
C3033	80mm	REP. CALIPER DELANTERO DODGE RAM 2500		JUN-23
C3093	45mm	REP. CALIPER DEL. RENAULT MASTER // MB. SPRINTER - BOSCH		OCT-22
C3201	36mm	REP. CALIPER TRASERA TOYOTA COROLLA		OCT-22
C3202	38mm	REP. CALIPER TRASERO PEUGEOT 307/308 - CITROEN C4		JUN-23
C4612	38mm	REP. CALIPER TRASERA COMPLETA (GOMA+METAL) CITROEN C5 // FORD FOCUS - FOCUS C-MAX - KUGA // RENAULT LAGUNA - MEGANE // VOLVO S40 - V50		OCT-22



JUEGOS DE PERNOS GUIA P/CALIPERS Y SUS PARTES



Código	Aplicación	Imagen	Sist.	Ubic.	Medida	Incorp
D7864	NUEVA APLICACIÓN: KIT PERNOS DE CALIPER FORD FIESTA KINETIC DESIGN				70 x 9,5	OCT-22
D7871	KIT DE PERNOS DESLIZ. C/ FUELLES PEUGEOT 206 - 306		BOSCH	-	68,50x10	AG-22
D7872	KIT DE PERNOS DESLIZANTES C/FUELLES HYUNDAI TUCSON 12/.. - KIA SPORTAGE 12/..		-	-	72x9,85	AG-22





LISTA DE NOVEDADES

Código	Aplicación	Imagen	Sist.	Ubic.	Medida	Incorp
D8081	KIT PERNOS CHEVROLET AVEO		-	-	59x10	AG-22
D8084	KIT BUJES C/RETIFICADO Y CROMO DURO IVECO 70C16 - 70HD		-	-	90x22	AG-22
D8084/K	KIT BUJES C/RETIFICADO Y CROMO DURO + TORNILLOS IVECO 70C16 - 70HD		-	-	90x22 120x12	AG-22
D8084/KF	KIT BUJES C/RETIFICADO Y CROMO DURO + TORNILLOS C/FUELLES IVECO 70C16 - 70HD (KIT COMPLETO)		-	-	90x22 120x12	AG-22



REPARAC. DE SERVO NACIONAL -
IMPORTADO



E

Código	Sist.	Imagen	Aplicación	Incorp
E1030	ATE		JGO. REP. SERVO RENAULT LOGAN - SANDERO	ABR-23
E1177	ATE		JUEGO DE REPARACIONES P/SERVO DT CHEVROLET CRUZE	AG-22
E1177DA	ATE		DIAFRAGMA SUPERIOR CHEVROLET CRUZE (similar a diafragma VW Amarok pero más chico) // Ø EXT.: 224mm - Ø AGUJ.: 35mm - ENTRECENROS 100mm	-
E1177DB	ATE		DIAFRAGMA INFERIOR CHEVROLET CRUZE (similar a diafragma VW Amarok pero más chico) // Ø EXT.: 241mm - Ø AGUJ.: 58mm - ENTRECENROS 100mm	-
E1178	AISIN		JUEGO REP. PARA SERVO SIMPLE TOYOTA COROLLA - E120 - FUNCARGO - VITZ	AG-22





LISTA DE NOVEDADES

Código	Sist.	Imagen	Aplicación	Incorp
E1178D	AISIN		DIAFRAGMA PARA SERVO SIMPLE TOYOTA COROLLA - E120 - FUNCARGO - VITZ // Ø EXT.: 241mm - Ø AGUJ.: 38mm	-
E1179	TRW		JUEGO REP. PARA SERVO SIMPLE CHEVROLET CRUZE - OTROS	AG-22
E1179D	TRW		DIAFRAGMA PARA SERVO SIMPLE CHEVROLET CRUZE - OTROS (similar al E1155D, tetones grandes) // Ø EXT.: 270mm - Ø AGUJ.: 52mm - ENTRECENROS 105mm	-
E1180	ATE		JUEGO REP. PARA SERVO VW PASSAT - TIGUAN	OCT-23
E1180D	ATE		DIAFRAGMA PARA SERVO VW PASSAT - TIGUAN // Ø EXT.: 290mm	OCT-23
E1181D	KDAC		DIAFRAGMA PARA SERVO CHEVROLET SPIN (CON TETONES) // Ø EXT.: 265mm	OCT-23
E5476	ATE		DIAFRAGMA RENAULT LOGAN - SANDERO // Ø EXT.: 236mm	ABR-23



PISTONES PARA CALIPERS



Cód.	Ø	Alt.	Descripción	Sistema	Imagen	Incorp
G01036	36	49	TOYOTA COROLLA 06/.. (TRASERO)	-		OCT-22
G01039	54	51	FIAT GRAND SIENA FORD ECOSPORT	-		AG-22



LISTA DE NOVEDADES

Cód.	Ø	Alt.	Descripción	Sistema	Imagen	Incorp
G01041	57	56	A. ROMEO GIULIETTA // AUDI A4 - A5 - Q3 // BMW SERIE 3 - XI - Z4 // CITROEN C4 // FIAT DOBLO - 500 // FORD C-MAX - FOCUS - KUGA - MONDEO - TRANSIT // HONDA ACCORD - CIVIC // IVECO DAILY	-		AG-22
G01042	34	46	HYUNDAI TUCSON (TRASERO) KIA SPORTAGE (TRASERO)	-		AG-22
G01043	48	54	RENAULT MASTER II 12/.. (TRASERO)	-		OCT-22
G01044	30	44	HONDA CITY - FIT 10/.. (TRASERO)			AG-23
G01045	54	48	HONDA CITY - FIT 10/.. (TRASERO)	-		OCT-22



FLEXIBLES PARA FRENOS



Código	Imagen	Descripción	Incorp.	Código	Imagen	Descripción	Incorp.
CHEVROLET							
H4114/1	 450mm	PRISMA - ONIX 13/.. SPIN 12/.. VER DEL.	OCT-22	H4121	 375mm	TRACKER (FRENO A TAMBOR) 13/.. TRAS	OCT-22
FIAT							
H2130	 530mm	CRONOS 18/.. DEL.	OCT-22	H2114	 455mm	PUNTO 09/.. DEL.	OCT-22
H9138	 440mm	500X 14/.. DEL.	OCT-22	H9140	 385mm	500X 14/.. TRAS.	OCT-22
H2230	 435mm	TORO 07/19 DOBLO 07/.. VER DEL.	OCT-22	H2231	 310mm	TORO 07/19 DOBLO 07/.. VER TRAS.	OCT-22





LISTA DE NOVEDADES

Código	Imagen	Descripción	Incorp.	Código	Imagen	Descripción	Incorp.
FORD							
H3123		F4000 (F/D) TRAS/DER.	OCT-22	H3124		F4000 (F/D) TRAS/IZQ.	OCT-22
H3192		MONDEO III 00/07 DEL.	OCT-22	H3184		RANGER (DOBLE CONEXIÓN) 11/.. TRAS.	OCT-22
JEEP							
H9138		RENEGADE 16/.. DEL.	OCT-22	H9140		RENEGADE 16/.. TRAS.	OCT-22
NISSAN							
H5846		FRONTIER 18/.. DEL.	OCT-22				
RENAULT							
				H8273		LOGAN II TRAS.	OCT-22
SUZUKI							
H7826		SAMURAI 1.3 - 1.9 85/04 DEL.	OCT-22				
VOLKSWAGEN							
H7080		T-CROSS 17/.. DEL.	OCT-22	H7088		T-CROSS 17/.. TRAS.	OCT-22
H7094		AMAROK V6 DEL.	NOV-23				



CABLES DE FRENO, EMBRAGUE Y SELECTORA

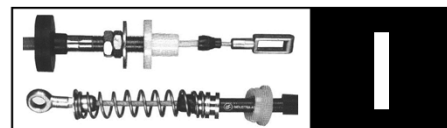

Código	Aplicación	Largo	Nº OEM	Incorp
i268	CAMBIO DE VELOCIDADES AUTOMATICO FORD TAUNUS	1300	78BR7A482A	AG-22
i790	EMBRAGUE GM/CHEVROLET/OPEL SUPREMA 2.0 - 2.2 MPFI 4 CIL. 92/98 - SENATOR 88/93	1226	90335385 - 669159	AG-22
i902	EMBRAGUE MANGO HEX. C/2 TUERCAS P-504			ENE-23
i3015	EMBRAGUE FIAT MAREA MOTOR 1.9 TD 95/02	1510	46448106 - 46797595	ENE-24
i3565	EMBRAGUE VW 1600 / SAFARI REFORZADO / KARMAN GHIA Ghia 72/..	2290	111721335C	JUN-22



LISTA DE NOVEDADES

Código	Aplicación	Largo	Nº OEM	Incorp
i3632	FRENO TRAS/D-I VW 1300 - 1500 - 1600 81/86	1770	1136097211 - 113609721L	JUN-22
i3676	EMBRAGUE VW BRAZILIA - REFORZADO	2345	adaptación 311721335A - 3117213351	JUN-22
i3694	EMBRAGUE RENAULT 5 MIRAGE			ENE-23
i3980	EMBRAGUE CON 2 CONTRAPESOS RENAULT 21 - NEVADA - RX - TXE - MEDALLON - ETOILE 87/..	1230	7700763190	AG-22
i4016	CAMBIO DE VELOCIDADES M. BENZ OMNIBUS 1725	10250	A3822600351	AG-22
i4019	CAMBIO DE VELOCIDADES M. BENZ OMNIBUS O500 RS	11000	A6292682891	AG-22
i4055	EMBRAGUE DAEWOO MATIZ 1.0 4V 05/..	835	96590793 - 25187023	AG-22
i4056	EMBRAGUE NISSAN TSURU III 1.6L 03/16	800	30770F4203	AG-22
i4488	EMBRAGUE GM/CHEVROLET/OPEL PICK-UP A10 - A20 - C10 - C20 85/88	730	94647409	AG-22
i4489	EMBRAGUE GM/CHEVROLET/OPEL CAMIÓN D40 85/88	725	94647410	AG-22
i4491	FRENO TRASERO GM/CHEVROLET/OPEL A10 - A20 - C10 - C20 - D10 - D20 85/88	1240	94637224	AG-22
i4495	FRENO DELANTERO FORD F4000 MOTOR MWM ASPIRADO 92/98	2185	T72609701	AG-22
i4539	EMBRAGUE GM/CHEVROLET/OPEL CHEVETTE 74/76	1190	9302835	AG-22
i4540	FRENO DELANTERO GM/CHEVROLET/OPEL A40 - C40 - D40 85/92	1490	94629727	AG-22
i4544	EMBRAGUE GM/CHEVROLET/OPEL PICK-UP A10 - C10 - D10 MOTOR 4 CILINDROS 79/84 - A14C y C14C 85/89	800	94602860	AG-22
i4578	FRENO TRASERO DERECHO/IZQUIERDO A CAMPANA VW POLO HATCH-SEDAN (BRASIL) 02/15	1660	6Q0609721K - 6Q0609721F	AG-22
i4635	CAMBIO DE VELOC. INSERCIÓN FIAT NUEVO PALIO (326) 1.4 MPI FIRE 8V (CAJA C514) ATTRACTIVE 17/..	1100	55261463	AG-22
i4636	CAMBIO DE VELOC. SELECCIÓN FIAT NUEVO PALIO (326) 1.4 MPI FIRE 8V (CAJA C514) ATTRACTIVE 17/..	1185	55261464	AG-22
i4654	CAMBIO DE VELOCIDADES CITROEN NUEVA JUMPER 05/17 // FIAT NUEVA DUCATO 05/18 // PEUGEOT NUEVA BOXER 05/17 // 2 CABLES UNIDOS CON GOMA	1038	71729169 - 2444V9 - 2444EC	AG-22
i4660	FRENO DELANTERO A CAMPANA CHEVROLET ONIX - PRISMA 13/..	190	52026809	AG-22
i4661	FRENO DEL. A CAMPANA CHEVROLET SPIN 12/..	230	52046580 - 52034393	AG-22
i4663	CAMBIO DE VELOCIDADES INSERCIÓN FIAT UNO II 1.4 MPI FIRE 10/.. -RÓTULA GRANDE- (EXT. PLÁSTICOS)	1095	55222272 - 68198829AA	AG-22
i4664	CAMBIO DE VELOCIDADES SELECCIÓN FIAT UNO II 1.4 MPI FIRE 10/.. -RÓTULA CHICA- (EXT. PLÁSTICOS)	1000	55222273 - 68198830AA	AG-22
i4670	CAMBIO DE VELOCIDADES TOYOTA YARIS 1.5 VVTI 16V 6 VELOC. 18/.. -2 CABLES UNIDOS POR GOMA-	1080	338200D760	AG-22
i4671	CAMBIO DE VELOC. CHEVROLET ONIX - PRISMA CAJA DE 5 VELOC. 20/.. -2 CABLES UNIDOS POR GOMA-	1085	24590069 - 24590218	AG-22
i4672	CAMBIO DE VELOCIDADES FORD FIESTA - COURIER 1.6L 16V 5 VELOC. 15/.. -2 CABLES CON GOMA UNIÓN-	1700	D2BZ7E395C	AG-22
i4689	CAMBIO DE VELOCIDADES VW NIVUS 1.0 T AT6 20/..	1400	2Q0713266M	AG-22





LISTA DE NOVEDADES

Código	Aplicación	Largo	Nº OEM	Incorp
i4695	CAMBIO VELOC. FIAT DUCATO - TALENTO 2.3 16V TURBO DIESEL MULTIJET -2 CABLES UNIDOS CON GOMA- 19/..	1050	55284171 - K68403724AA	AG-22
i4712	BIELETA PEDAL DE EMBRAGUE PEUGEOT 206 - 207 - HOGGAR	-	212830	OCT-22
i4713	BIELETA PEDAL DE EMBRAGUE CITROEN BERLINGO // PEUGEOT PARTNER	-	212831	OCT-22
i4716	FRENO TRASERO EXTENSION A CAMPANA CHEVR. ONIX y PRISMA 13/.. - COBALT y SONIC 12/..	230	95492584 - 95231322	OCT-22
i4717	FRENO TRASERO EXTENSION A CAMPANA CHEVR. SPIN 12/.. - TRACKER y TRAX 13/..	235	95492583	OCT-22
i4719	FRENO TRASERO A DISCO FORD FOCUS III 13/.. - 2 CABLES CON CHAPA UNION	1970	AV612A603BL	OCT-22
i4721	CAMBIO DE VELOCIDADES (CAMBIO AT6) CAJA AUTOMATICA // CITROEN C4 CACTUS 1.2 T PURETECH - 1.6 16V 17/... - C-ELYSEE 1.6 16V 17/20 - DS3 1.2 T PURETECH 17/... // PEUGEOT 301 1.6 16V 17/18 - PEUGEOT 208 1.6 16V EC5 12/... - PEUGEOT2008 1.6 16V EC5 16/..	1320	9814628080	AG-22
i4729	CAMBIO VELOC. AUTOMÁT. FORD RANGER 12/..	1255	AB397E395AF	ENE-24
i4730	FRENO TRAS. A CAMPANA (SIN ABS) -2 CABLES CON CHAPA UNIÓN- FORD FOCUS II 08/13	2980	1707756 - 3M512A603EC	MAR-23
i4731	FRENO DE MANO TRASERO A DISCO FORD FOCUS II	3730	1707757 - 3M512A603FC	ENE-24
i4745	FRENO TRASERO DERECHO (SIN CHAPAS SOPORTE) NISSAN FRONTIER MWM 2.8 DTI 03/08	2270	365306S302	AG-22
i4746	FRENO TRASERO IZQUIERDO NISSAN FRONTIER MWM 2.8 DTI 03/08	1095	365316S302	AG-22
i4749	FRENO DELANTERO NISSAN FRONTIER MWM 2.8 DTI 03/08	2215	364028Z311	ENE-24
i4750	FRENO TRASERO DERECHO NISSAN FRONTIER 2.3 DCI 16/18	2175	365304KH0B	ENE-24
i4751	FRENO TRASERO IZQUIERDO NISSAN FRONTIER 2.3 DCI 16/18	2440	365314KH0B	ENE-24
i4752	BIELETA PASAJE DE CAMBIOS PEUGEOT 207 - HOGGAR (CAJA MA) CHASIS 1148077/..	80	2454G8	ENE-24
i4753	BIELETA PASAJE DE CAMBIOS CITROEN XSARA - XSARA PICASSO	90	245286	ENE-24
i4754	BIELETA SELECCIÓN DE CAMBIOS CITROEN BERLINGO // PEUGEOT PARTNER // (CAJA BE4R)	115	2454F5	ENE-24
i4755	BIELETA SELECCIÓN DE CAMBIOS PEUGEOT 206 - 207 - HOGGAR (CAJA BE4R)	120	2454G4	ENE-24
i4756	BIELETA SELECCIÓN DE CAMBIOS PEUGEOT 206- 207 - HOGGAR (CAJA MA)	160	2454G5	ENE-24
i4757	BIELETA PASAJE DE CAMBIOS CITROEN BERLINGO // PEUGEOT PARTNER - 206 - 207 - HOGGAR // (CAJA BE4R)	280	245281	ENE-24
i4758	EMBRAGUE REGULACION AUTOMATICA C/CONTRAPESO CITROEN BERLINGO 1.4 N (75 CV) - 1.6 16v (110 CV) - 1.6 HDI (90 CV) 10/16 // PEUGEOT PARTNER 1.4 N (75 CV) - 1.6 16v (110 CV) - 1.6 HDI (90 CV) 10/16	880	9825669080	AG-22





LISTA DE NOVEDADES

Código	Aplicación	Largo	Nº OEM	Incorp
i4759	EMBRAGUE REGULACION MANUAL SIN CONTRAPESO CITROEN BERLINGO 1.4 N (75 CV) - 1.6 16v (110 CV) - 1.6 HDI (90 CV) 10/16 // PEUGEOT PARTNER 1.4 N (75 CV) - 1.6 16v (110 CV) - 1.6 HDI (90 CV) 10/16	940	ADAPT. 9825669080 - 9837204380	ENE-23
i4766	BIELETA PEDAL DE EMBRAGUE CITROEN BERLINGO // PEUGEOT 306 - PARTNER	-	212822	ENE-23
i4768	FRENO TRAS/DER. A CAMPANA FIAT PULSE 1.3 DRIVE - 1.0T IMPETUS 22/..	1620	52156077	ENE-23
i4769	FRENO TRAS//IZQ. A CAMPANA FIAT PULSE 1.3 DRIVE - 1.0T IMPETUS 22/..	1650	52156078	ENE-23
i4770	FRENO TRAS/DER-IZQ. A DISCO VW VENTO 11/18	1625	5C0609721BC	ENE-23
i4771	FRENO DEL. A CAMPANA CHEVROLET SONIC 12/.. - COBALT 13/..	185	95229769 - 95937512	ENE-23
i4772	FRENO DEL. TOYOTA COROLLA 08/14	320	4641002160 - 4641002170	ENE-23
i4776	CAMBIO VELOCIDADES FIAT PULSE IMPETUS 1.0 - 1.3 DRIVE 1.3	1215	52150088	ENE-24
i4777	FRENO DELANTERO NISSAN FRONTIER 2.3 DCI 18/.. // RENAULT ALASKAN 2.3 DCI 20/..	555	364024KD0B	ENE-24
i4778	FRENO TRASERO DERECHO NISSAN FRONTIER 2.3 DCI 18/.. // RENAULT ALASKAN 2.3 DCI 20/..	2180	365305JL0A	ENE-24
i4779	FRENO TRASERO IZQUIERDO NISSAN FRONTIER 2.3 DCI 18/.. // RENAULT ALASKAN 2.3 DCI 20/..	2490	365315JL0A	ENE-24
i4781	FRENO TRASERO DERECHO NISSAN VERSA MOTOR 1.6 (107 CV) 13/20	1835	365303BA0A	ENE-24
i4782	FRENO TRASERO IZQUIERDO NISSAN VERSA MOTOR 1.6 (107 CV) 13/20	1825	365313BA0A	ENE-24
i4785	FRENO TRASERO DER/IZQ A CAMPANA 14/.. RENAULT LOGAN - SANDERO	1730	365306778R	MAY-23



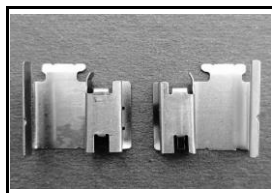

P1584

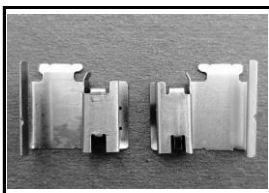

P1585



P1608



P1609



P1610



P1611



P1625



P1626



P1633

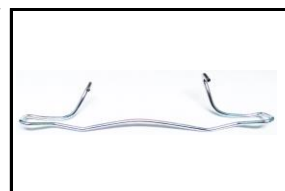

P2650



P9107



P9108



P9109



P9110



P9111



P9112

Código	Marca	Aplicación	Incorp
P1584	CITR. - PEUG. - VW	ANTIRRUIDO DER/IZQ.- CITR. C4 VTS - C4 // PEUG. P307 // VW AMAROK - BOSCH NVA. APLICACIÓN	SEP-23
P1585	CITR. - PEUG. - VW	ANTIRRUIDO DER/IZQ.- CITR. C4 VTS - C4 // PEUG. P307 // VW AMAROK - BOSCH - NVA. APLICACIÓN	SEP-23
P1608	TOYOTA	JGO. LEVA IZQUIERDA TOYOTA HILUX 05/..	FEB-23
P1609	TOYOTA	JGO. LEVA DERECHA TOYOTA HILUX 05/..	FEB-23
P1610	IVECO	JUEGO LEVA IVECO (TODOS)	MAR-23
P1611	CITR. - FIAT - PEUG.	JGO. LEVA CITROEN JUMPER - FIAT DUCATO - PEUGEOT BOXER 01/17	SEP-23
P1625	CHEVROLET	REGISTRO IZQUIERDO CHEVROLET ASTRA - CORSA II - MERIVA	FEB-23
P1626	CHEVROLET	REGISTRO DERECHO CHEVROLET ASTRA - CORSA II - MERIVA	FEB-23
P1633	FORD	PERNO PARA GATILLO FORD RANGER	SEP-23
P2650	VW	TRABA PASTILLA VW BORA - GOL - PASSAT - VENTO	ENE-23
P9107	FIAT - FORD	REGULADOR IZQUIERDO FIAT QUBO - FORD ECOSPORT	MAR-23
P9108	FIAT - FORD	REGULADOR DERECHO FIAT QUBO - FORD ECOSPORT	MAR-23
P9109	IVECO	REGISTRO IVECO 60.13 - 70.13V 8.5TN	MAR-23
P9110	FIAT	REGISTRO FIAT DUCATO R15/16 (TODOS)	MAR-23



LISTA DE NOVEDADES

Código	Marca	Aplicación	Incorp
P9111	MITSUBISHI	REGISTRO DERECHO MITSUBISHI MONTERO 89/95	MAR-23
P9112	MITSUBISHI	REGISTRO IZQUIERDO MITSUBISHI MONTERO 89/95	MAR-23





LISTA DE NOVEDADES



CILINDROS DE FRENO

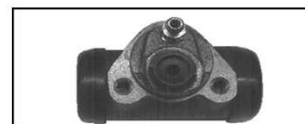

Q

Cód.	Aplicación	Año	Med	Sist.	Ubic.	Imagen	Inc.
Q454	CIL. RDA. FORD FOCUS III	07/14	13/16"	-	TRAS		ABR-23
Q9905	CIL. RDA. FIAT DOBLO - 500 // VW POLO - T-CROSS	17/..	13/16"	-	TRAS		ABR-23
Q9906	CIL. RDA. VW NVO POLO RCA: 10x1	18/..	3/4"	-	TRAS		ABR-23
Q10111	CIL. RDA. NISSAN FRONTIER RCA: 10x1 C/CONO	-	1"	-	TRAS		ABR-23
Q10112	CIL. RDA. NISSAN SENTRA	-	5/8"	-	TRAS		ABR-23
Q10113	CIL. RDA. NISSAN KICKS - VERSA RCA: 10x1 C/CONO	16/23	3/4"	-	T/IZQ		NOV-23
Q10114	CIL. RDA. NISSAN KICKS - VERSA RCA: 10x1 C/CONO	16/23	3/4"	-	T/DER		NOV-23
Q18002	CIL. RDA. HONDA CIVIC CRV - CRX	-	13/16"	-	T/IZQ		JUN-23
Q18003	CIL. RDA. HONDA CIVIC CRV - CRX	-	13/16"	-	T/DER		JUN-23



LISTA DE NOVEDADES

Cód.	Aplicación	Año	Med	Sist.	Ubic.	Imagen	Inc.
Q18004	CIL. RDA. HONDA CIVIC CRV - CRX	-	3/4"	-	T/IZQ		JUN-23
Q18005	CIL. RDA. HONDA CIVIC CRV - CRX	-	3/4"	-	T/DER		JUN-23
Q18006	CIL. RDA. HONDA CITY - FIT	-	3/4"	-	TRAS		JUL-23
Q85810	CIL. RDA. RENAULT KWID	17/..	5/8"	-	TRAS		ABR-23



BBAS. EMBRAGUE, FRENO Y CIL. AUX. NACIONAL - IMPORTADO



**QB
QR
QS**

Cód.	Aplicación	Año	Med	Sist.	Tipo	Imagen	Inc.
QB039	CRAPODINA HIDRAULICA DE EMBRAGUE MERCEDES BENZ 712 - 914 - 1215 - 1620 - ATEGO - AXOR	VER	23mm				DIC-22
QB040	CRAP. HIDR. EMBR. FORD KUGA 2.5T 09/14 - MONDEO 2.5T 07/14 // LAND ROVER FREELANDER II 2.2 DIESEL 06/..	VER	Ø 31mm				SEP-22
QB041	CRAPODINA HIDRAULICA DE EMBRAGUE (PLÁSTICO) CHEVROLET CRUZE 1.4T	16/..	Ø 27mm				SEP-22
QB042	CRAP. HIDR. EMBR. CITROEN C4 GRAND PICASSO 1.6 THP, 1.6 HDI - C4 LOUNGE 1.6 THP, 1.6 HDI 13/.. - DS3 1.6 THP - DS4 1.6 THP // PEUGEOT 208 1.6 THP - 308 1.6 THP, 1.6 HDI - 408 1.6 THP, 1.6 HDI - 2008 1.6 THP - 3008 1.6 THP	VER	Ø 24mm				SEP-22





LISTA DE NOVEDADES

Cód.	Aplicación	Año	Med	Sist.	Tipo	Imagen	Inc.
QB043	CRAP. HIDR. EMBR. CITROEN C4 GRAND PICASSO 1.6 THP, 1.6 HDI - C4 LOUNGE 1.6 THP, 1.6 HDI 13/.. - DS3 1.6 THP - DS4 1.6 THP // PEUGEOT 208 1.6 THP - 308 1.6 THP, 1.6 HDI - 408 1.6 THP, 1.6 HDI - 2008 1.6 THP - 3008 1.6 THP	VER	Ø 23mm				SEP-22
QB044	CRAPODINA HIDRAULICA DE EMBRAGUE TOYOTA COROLLA 09/.. - ETIOS 16/..	VER	Ø 28mm				SEP-22
QB046	CRAPODINA HIDRAULICA DE EMBRAGUE (CAÑO LARGO) NISSAN TIIDA 08/.. - X-TRAIL 11/.. // RENAULT DUSTER 11/.. - FLUENCE 10/.. - KOLEOS 09/.. - MEGANE III 11/.. CONEXIÓN: ENCHUFAR	VER	5/8"				AG-22
QB055	CRAPODINA HIDRAULICA DE EMBRAGUE FIAT TORO 16/.. - TORO 2.0 // JEEP COMPASS 17/.. - RENEGADE 16/..	VER	23mm				DIC-22
QB3110	BOMBA DE EMBRAGUE HYUNDAI TUCSON // KIA SPORTAGE	10/..	5/8"				SEP-22
QB10250	BOMBA DE EMBRAGUE TOYOTA COROLLA 09/.. - ETIOS 12/..	VER	5/8"				SEP-22
QB12300	BBA. EMBRAGUE NISSAN SENTRA 13/16 - TIIDA 07/15 - VERSA 13/15	VER	5/8"				JUL-23
QB12301	BBA. EMBRAGUE NISSAN MARCH 12/.. - NOTE 15/.. - VERSA 15/20	VER	5/8"				JUL-23
QB13610	BBA. EMBRAGUE (CAJA AUTOMÁTICA EASYTRONIC) CHEVR. CORSA II - MERIVA	03/..					SEP-22





LISTA DE NOVEDADES

Cód.	Aplicación	Año	Med	Sist.	Tipo	Imagen	Inc.
QB13611	BBA. EMBRAGUE CHEVROLET CRUZE 1.4 TURBO	16/..	5/8"				SEP-23
	CONEXIÓN: ENCHUFAR						
QB15605	BOMBA DE EMBRAGUE FORD ECOSPORT 12/17 - ECOSPORT 17/.. - FIESTA KINETIC 10/..	VER	5/8"				SEP-22
	CONEXIÓN: ENCHUFAR						
QB17103	BBA. EMBRAGUE SUZUKI SWIFT	08/..	5/8"				AG-22
	CONEXIÓN: ENCHUFAR						
QB17104	CILINDRO AUXILIAR DE EMBRAGUE SUZUKI SWIFT	08/..	13/16"				AG-22
	CONEXIÓN: ENCHUFAR						
QB17203	BBA. EMBRAGUE SUZUKI GRAND VITARA JIII	08/..	5/8"				AG-22
	CONEXIÓN: ENCHUFAR						
QB19100	BBA. EMBRAGUE DODGE JOURNEY 08/.. // JEEP COMPASS 06/.. - PATRIOT 07/..	VER	11/16"				AG-22
	CONEXIÓN: ENCHUFAR						
QB23503	BBA. FRENO C/DEPOSITO VW GOL TREND SAVEIRO TREND MOTOR MSI	14/..	7/8"	DC			SEP-23
	CONEXIÓN 2 - 10x1 // 2 - 12x1						
QB24108	BOMBA DE EMBRAGUE NISSAN XTRAIL 08/14 // RENAULT KOLEOS 09/15	VER	5/8"				SEP-22
	CONEXIÓN: ENCHUFAR						
QB24109	BOMBA DE EMBRAGUE RENAULT DUSTER - DUSTER OROCH	-	5/8"				SEP-22
	CONEXIÓN: ENCHUFAR						
QB24110	BBA. EMBRAGUE RENAULT LOGAN 13/.. - SANDERO 15/.. - STEPWAY 15/..	VER	5/8"				AG-22
	CONEXIÓN: ENCHUFAR						





LISTA DE NOVEDADES

Cód.	Aplicación	Año	Med	Sist.	Tipo	Imagen	Inc.
QB24111	BBA. EMBRAGUE RENAULT FLUENCE - MEGANE II		5/8"				ENE-24
	<i>CONEXIÓN: ENCHUFAR</i>						
QB25104	BBA. EMBRAGUE FIAT TORO // JEEP RENEGADE		5/8"				JUL-23
	<i>CONEXIÓN: ENCHUFAR</i>						
QB25105	BBA. EMBRAGUE FIAT LINEA - PUNTO	08/..	5/8"				AG-22
	<i>CONEXIÓN: ENCHUFAR</i>						
QB25106	BOMBA DE EMBRAGUE FIAT ARGO - CRONOS - GRAND SIENA - PALIO NOVO - UNO FASE II 10/..	-	5/8"				SEP-22
	<i>CONEXIÓN: ENCHUFAR</i>						
QB29101	BOMBA DE EMBRAGUE CITROEN C4 // PEUGEOT 307 - 308	-	5/8"				SEP-22
	<i>CONEXIÓN: ENCHUFAR</i>						
QB32101	BOMBA DE EMBRAGUE (ALUMINIO) CHERY TIGGO 1.6	08/16	5/8"				SEP-22
QB32102	BBA. EMBRAGUE (ALUMINIO + PLÁSTICO) CHERY TIGGO 2.0	08/16	3/4"				SEP-22
QB32103	CILINDRO AUXILIAR DE EMBRAGUE CHERY TIGGO	08/13	13/16"				SEP-22
	<i>CONEXIÓN: M10x1</i>						
QR4207	BBA. EMBR. FORD CARGO	11/..	1"				ABR-23
QR4407	CIL. AUX. EMBR. FORD CARGO	-	1 1/8"				ABR-23





LISTA DE NOVEDADES

Cód.	Aplicación	Año	Med	Sist.	Tipo	Imagen	Inc.
QS2003	BBA. FRENO DC TOYOTA HILUX - SW4 2.4 - 2.8	15/..	7/8"				NOV-23
	2 SAL.: 12x1 C/CONO						
QS06268	BBA. FRENO FORD RANGER 2.2TDCI - 2.5N - 3.2TDCI 4x2 - 4x4 MT	12/16	7/8"				ENE-24
	2 SAL.: 10x1						
QS07120	BBA. FRENO DC CHEVROLET S10 2.8 LS/LT/LTZ (MANUAL)	12/17	7/8"	BOSCH			ABR-23
	2 SAL.: 10x1						
QS07121	BBA. FRENO DC CHEVROLET S10 2.8 LS/LT/LTZ (AUTOMÁTICO)	12/17	7/8"	BOSCH			ABR-23
	2 SAL.: 12x1						
QS13115	BBA FRENO M. BENZ VITO 111 - FURGON 119 - COMBI 121 - TOURER C/ABS	15/..	1 1/16"	TRW			SEP-23
	2 SAL.: 12x1						
QS16214	BBA. FRENO CITROEN BERLINGO - XSARA // PEUGEOT 306 - PARTNER // (todos c/ABS)	97/15	15/16"	ATE			MAY-22
	2 SAL.: 10x1 - 12x1						
QS18110	BBA. FRENO RENAULT CLIO II - KANGOO - KANGOO EXPRESS C/ABS	97/08	7/8"	BOSCH			JUN-22
	2 SAL.: 10x1 - 12x1						
QS18158	BBA. FRENO RENAULT KWID	17/..	3/4"	BOSCH			AG-23
	2 SAL.: 10x1						
QS18159	BBA. FRENO RENAULT MEGANE II - SCENIC II		15/16"	-			MAY-23
	2 SAL.: 12x1						
QS21230	BBA. FRENO VW AMAROK 2.0TDI (ALUMINIO - SIN DEPOSITO)	10/16	1 1/16"				ENE-24
	2 SAL.: 12x1						





LISTA DE NOVEDADES

(1254) RD12484M
CHEVROLET TRACKER 17/..

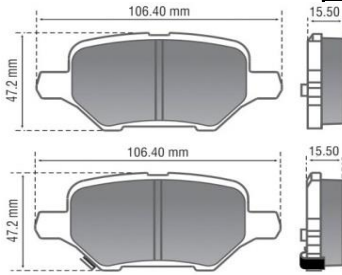

(1079) RD12485M
AUDI Q5 08/.. - A4 08/12 - A5 08/12

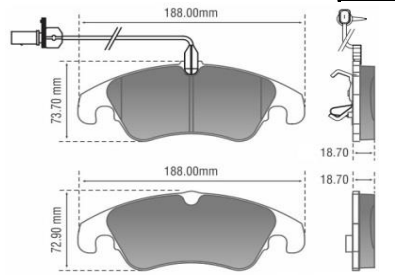

(1236) RD12486
CHEVROLET ONIX 1.0 TURBO 19/..

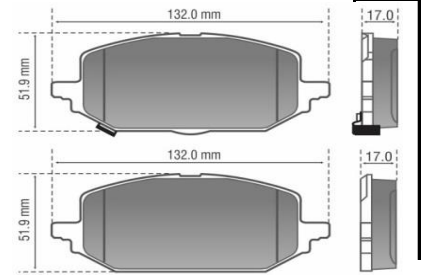

(1175) RD12488
KIA PICANTO 11/..

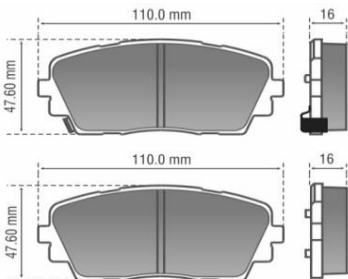

(0916) RD12495M
CITROEN JUMPY II 1.6 + 2.0 HDI 07/.. - SPACE TOURER 06/.. // FIAT SCUDO II 1.6 - 2.0 07/.. // PEUGEOT EXPERT 06/.. - EXPERT II TEPEE 1.6 - 2.0 07/..

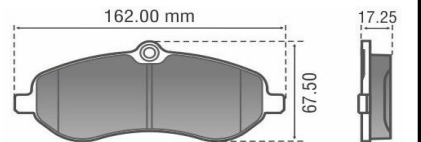
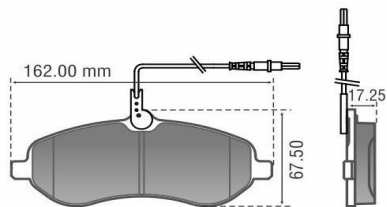

(0899) RD12497M

HYUNDAI CRETA 1.6 - 2.0 ATTITUDE - PULSE - PRESTIGE 16/.. - I30 - I30 CW 1.4 - 1.6 - 2.0 07/.. // KIA CARENS II EX LX- CRDI 1.6 - 1.8 - 2.0 02/.. CERATO 1.6 - 2.0 EX FORTE 10/.. - SOUL II 1.6 - 2.0 CVVT 14/..

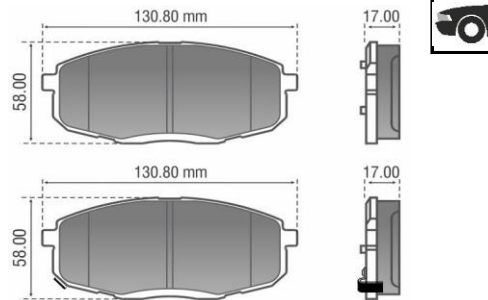

(0520) RD12500M

IVECO EURO RIDER 99/.. // M. BENZ ACTROS 1938 98/.. // SCANIA K-124 - 230 - 270 - 310 - 340 - 380 4x2 08/.. - SERIE 4 R144 LB 99/.. - SERIE 4 T124 6B 99/.. // KNORR

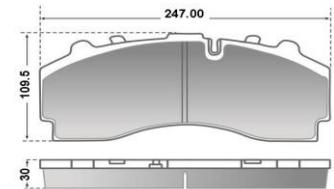

(1071) RD12506M

AUDI A3 II - S3 1.4 TSI - 1.8 - 2.0 TDI 12/.. - Q2 TFSI 2.0 QUATTRO 16/.. // SEAT ALHAMBRA II 1.4 TSI - 2.0 TDI 16V 4WD 10/.. // VW GOLF VII 1.4 TSI - 2.0 GTI 18/.. - PASSAT CC 2.0 TSI - 3.6 TFSI 08/.. - SHARAN II 1.4 TSI - 2.0 TDI 16V 4WD 10/.. - TIGUAN II 1.4 TSI - 2.0 TDI 17/..

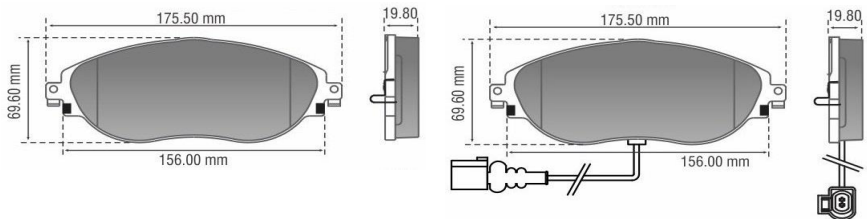

(1131) RD12511M

TOYOTA COROLLA 2.0 16V CVT 20/.. - 1.8 - HYBRID 20/..

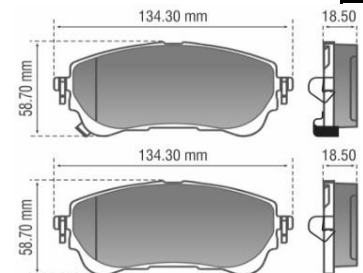

(1250) RD12512M

TOYOTA COROLLA 2.0 16V CVT 20/.. - 1.8 - HYBRID 20/..

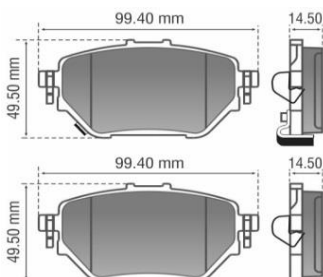

RD12513M

CITROEN C4 VTR 05/.. // PEUGEOT 2008 1.6 15/..

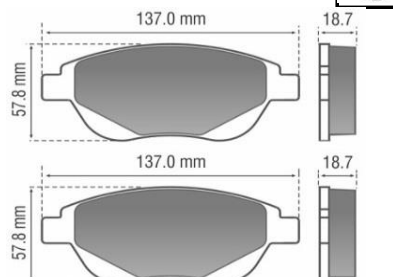

(0989) RD12522M

FIAT ARGO 1.8 - CRONOS - LINEA - PALIO WEEKEND ADVENTURE - STRADA ADVENTURE

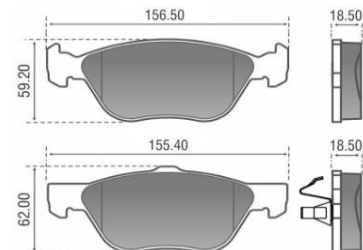



LISTA DE NOVEDADES

(1080) RD12523M

AUDI A4 1.8 - 2.0 - 2.7 - 3.2 TDI - TFSI 16V 07/.. - A5 QUATTRO
2.0 - 2.7 - 3.0 - 3.2 TDI TFSI 09/.. - A6 QUATTRO
2.0 - 2.7 - 3.0 - 3.2 TDI TFSI 11/.. - A7
SPORTBACK 2.8 - 3.0 TDI - FSI 10/.. - Q5
QUATTRO 2.0 - 3.0 - 3.2 TDI TFSI 09/.. // TRW

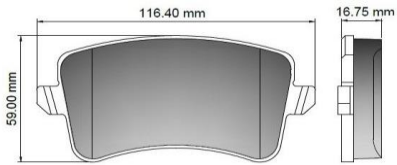

RD12524M

BMW SERIE 3 99/08

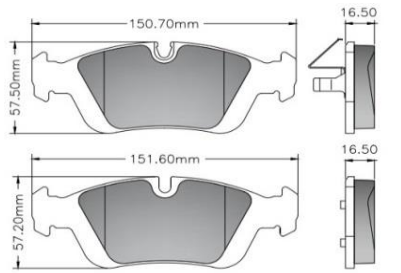

RD12526M

BMW SERIE 3 99/08

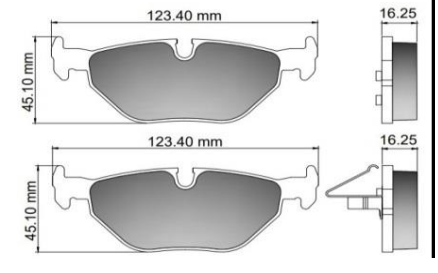

(1149) RD12527M

CITROEN C4 GRAND PICASSO 1.2 - 1.6 - 2.0 HDI 13/.. - C4 PICASSO 1.2 - 1.6 - 2.0 HDI 13/.. // DS7 // PEUGEOT 3008 THP 1.6 - 2.0 HDI 14/.. - 308 II SW 1.2 - 1.6 2.0 HDI 14/.. - BOSCH

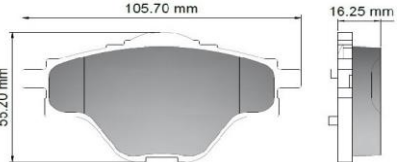
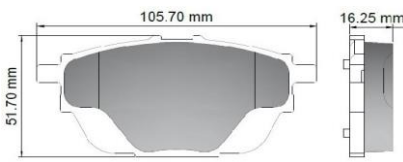

(1206) RD12530M

AUDI A7 II SPORTBACK 10/17 // VOLKSWAGEN TOUAREG 11/17

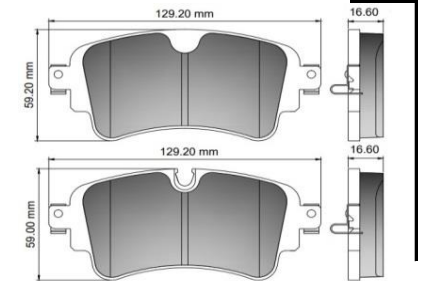

RD12531M

CHEVROLET TRACKER 1.2 TURBO 20/..

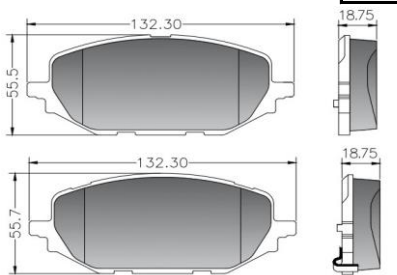

RD12532M

BMW SERIE 1

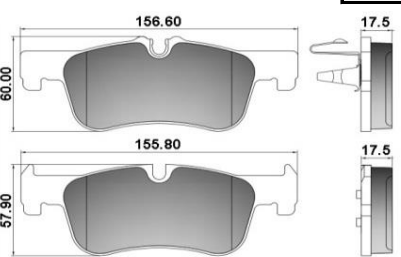

RD12533M

CITROEN C4 PICASSO II - GRAND PICASSO II 1.6 16/.. - BERLINGO K-9 19/.. // PEUGEOT PARTNER K-9 19/..

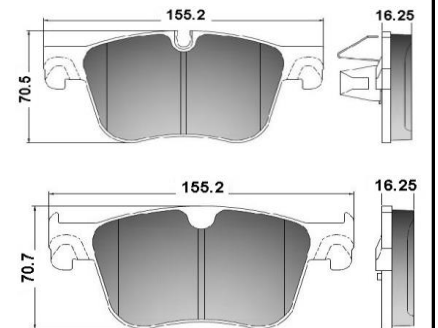

(1246) RD12535M

M. BENZ SPRINTER III 215 - 216 - 217 - 311 - 315 - 317 - 411 - 414 - 416 CDI 18/.. - BREMBO

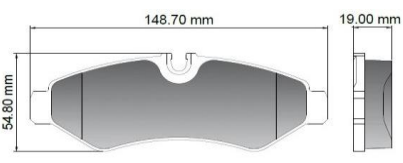

(1260) RD12536M

MERCEDES BENZ SPRINTER 516 19/..

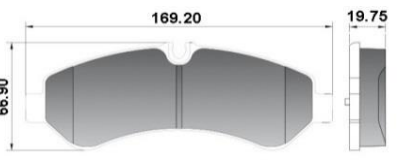

(0952) RD12537M

HONDA CITY - FIT - WR-V EX - EXL 1.5

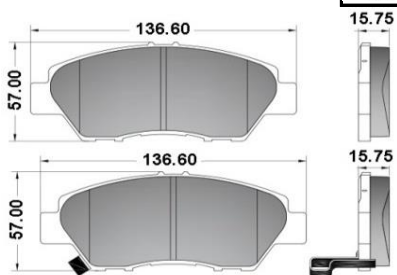

RD12544M

BMW SERIE 3 (E90 - E91 - E92) 06/12 - X1 (E84) 10/14

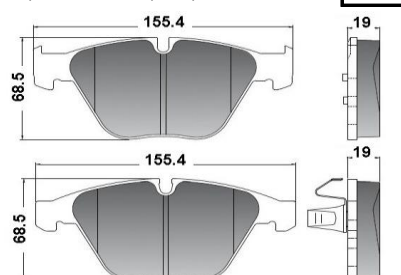

RD12548M

CHEVROLET EQUINOX 1.5 18/.. LLANTA 17"

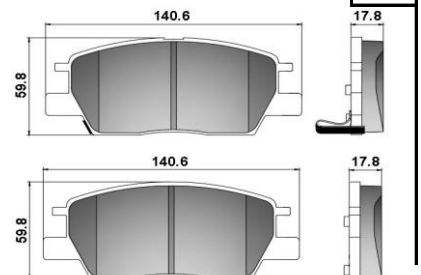



LISTA DE NOVEDADES

RD12549M

CHEVROLET EQUINOX 1.5
TURBO 18/..

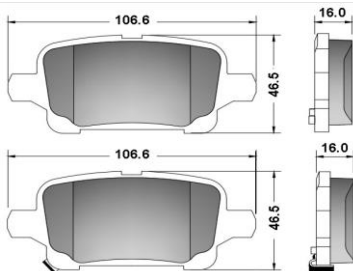

RD12550M

CITROEN C4 - C5 - DS4 //
PEUGEOT 308 - 508 - RCZ

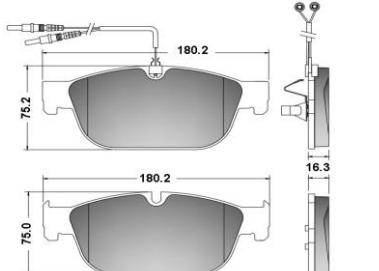

RD12552M

BMW X1 15/.. - BMW 2 ACTIVE //
MINI CLUBMAN

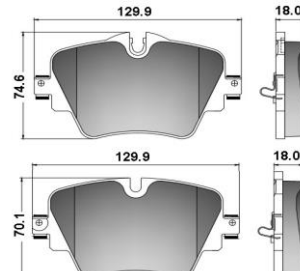

RD12553M

BMW X1 15/.. - BMW 2 ACTIVE //
MINI CLUBMAN

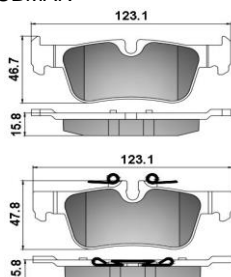

RD12554M

CITROEN C4 - C4 PICASSO -
BERLINGO // PEUGEOT 5008 -
PARTNER // DS4

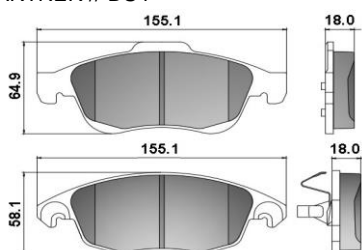

RD12555

CITROEN C4 // PEUGEOT 207 -
207SW - 307

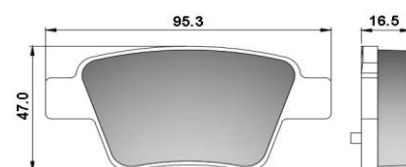

(0979)

RD12959AM

A. ROMEO 156 2.0 00/02 // FIAT
LINEA 1.4, 1.8 08/.. - BRAVO 11/..

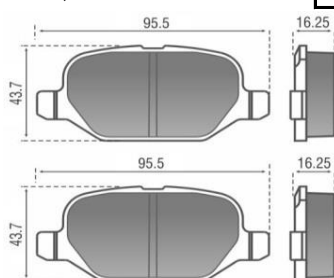

(0852)

RD12902AM

M. BENZ ACCELO 915-C 16/.. - ATEGO I 1017 a 1023 - 712 a 717 - 812 a 823 -
917 a 923 98/..

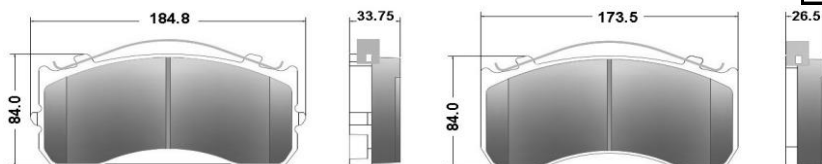

(1219)

RD12972M

MB SPRINTER 3.5 - 3T. - 4.6T. -
5T. - VITO NVA. APLIC.

